

AN INTRODUCTION TO SEWER NETWORK DESIGN USING SWMM

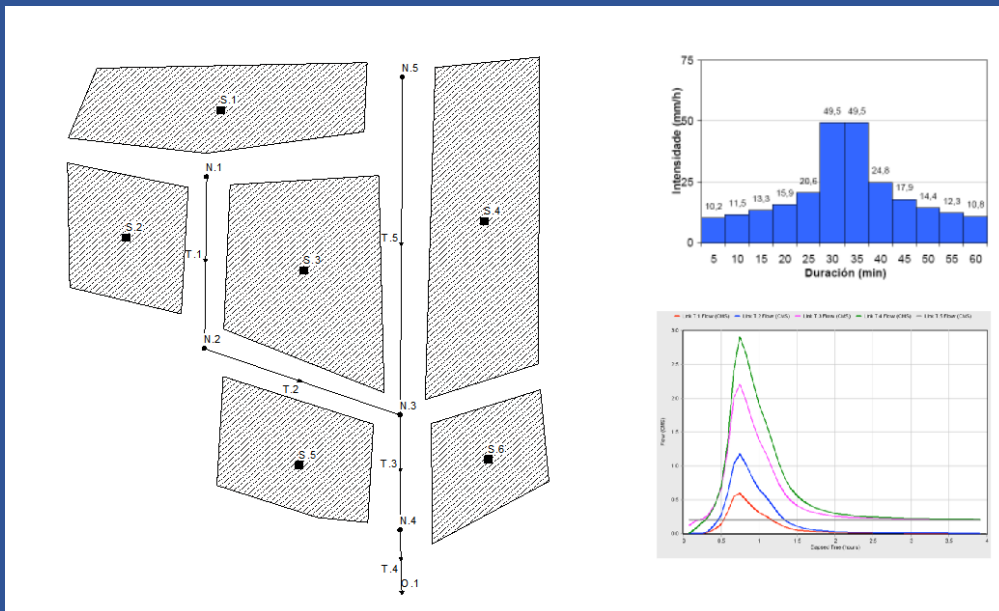

Jose Anta Álvarez
Acacia Naves García-Rendueles
Juan Naves García-Rendueles

An introduction to sewer network design using SWMM

Jose Anta Álvarez
Acacia Naves García-Rendueles
Juan Naves García-Rendueles

A Coruña
2020

Servizo de Publicacións
Universidade da Coruña

An introduction to sewer network design using SWMM

ANTA ÁLVAREZ, Jose

NAVES GARCÍA-RENDUELES, Acacia

NAVES GARCÍA-RENDUELES, Juan

A Coruña, 2019

Universidade da Coruña, Servizo de Publicacións

DOI: <https://doi.org/10.17979/spudc.9788497497909>

Number of pages: 54

Table of contents: p. iii

Depósito legal: C 1437-2020

ISBN: 978-84-9749-790-9

CDU: [628.2/.4:004.4SWMM](083.131)

Thema: TQSR | TNF | 4Z-ES-AF

EDICIÓN

Universidade da Coruña, Servizo de Publicacións <<http://www.udc.gal/publicacions>>

© edition, University of A Coruna

© texts, graphics, and figures: the authors

This book is an introductory manual for sewer network design using Storm Water Management Model (SWMM). This manual consists of two files: (i) the introductory document (pdf), and (ii) an additional electronic file containing complementary files with the resources needed to develop SWMM examples. This information is given in Section 6 of the manual (§6, p. 51). It can be downloaded from the persistent URL <https://doi.org/10.17979/spudc.9788497497909> (UDC institutional repository). In order to use these data, we recommend to copy “SWMM Manual” folder from the compressed file to C:\Manual SWMM path.

This manual is used in the teaching activities in University of A Coruna (UDC) Master's Degree in Civil Engineering as well as in the International Master's Degree in Water Engineering. A Spanish version has been previously published by University of A Coruna Press: it can be downloaded from the persistent URL <https://doi.org/10.17979/spudc.9788497497336> (UDC institutional repository).



This work is licensed under a Creative Commons Attribution-NonCommercial-ShareAlike 4.0 International License (CC BY-NC-SA 4.0)

TABLE OF CONTENTS

1	INTRODUCTION.....	1
2	SWMM MODEL.....	2
2.1	Introduction	2
2.2	Sewer network conceptual model in SWMM	3
2.3	Main elements of the sewerage systems in SWMM	6
2.3.1	Visual objects	6
2.3.2	Non-visual objects.....	10
3	PERFORMING THE SWMM MODEL OF THE SCIENTIFIC PLARFORM OF URBAN HYDROLOGY TESTS FACILITY.....	11
3.1	Description of the Scientific Platform for Urban Hydrology Tests facility.....	11
3.2	Problem statement.....	12
3.2.1	Subcatchment definition.....	12
3.2.2	Nodes and conduits	13
3.2.3	Rainfall	14
3.2.4	Dry weather wastewater flows	15
3.2.5	Results.....	15
3.3	Procedure to solve the problem	15
3.3.1	Setting model by-default properties.....	15
3.3.2	Drainage network and study are sketch up	17
3.3.3	Editing object properties.....	19
3.3.4	Analysis and simulation options.....	21
3.4	Model results	23
4	SIMPLIFIED COMBINED SEWER NETWORK MODELLING	26
4.1	Problem statement.....	26
4.2	Procedure to solve the problem	28
4.2.1	Model by default properties	29
4.2.2	Drainage network and study area sketch up	30
4.2.3	Editing object properties.....	30
4.2.4	Analysis and simulation options.....	32
4.3	Model results	33
5	CSO STORMWATER TANK DESIGN	37
5.1	Problem statement.....	37
5.2	CSO stormwater tank sizing using the design rainfall	37
5.3	CSO stormwater tank sizing using the average year rainfall record.....	44
6	DATA PROVIDED TO DEVELOP THE EXAMPLES	51
7	REFERENCES.....	52

1 INTRODUCTION

Storm Water Management Model (SWMM) software has been developed by the United States Environmental Protection Agency (US-EPA) and it is widely used worldwide for the design and analysis of sewer and drainage networks. SWMM resolves rainfall-runoff processes in urban catchments, flow transport within sewer pipe networks and other common drainage structures such as pumping stations or stormwater tanks. SWMM also includes a module for Low Impact Development (LID) modelling. In Europe, LID solutions are usually called Sustainable urban Drainage Systems (SuDS). SWMM is an open-source program and can be downloaded free of charge from the United States Environmental Protection Agency (US-EPA) website: <www.epa.gov/water-research/storm-water-management-model-swmm>.

The main objective of this manual is to use SWMM model as a teaching tool to improve the learning of the hydrological processes developed in urban sewerage and drainage systems, and to introduce basic skills for their proper design. For this purpose, a series of modelling problems are proposed with an increasing complexity level. This manual covers first the design of simplified drainage networks. Wastewater dry weather flow is then incorporated into the study cases. Finally, the manual addresses the design of Combined Sewer Overflow (CSO) tanks.

The proposed exercises are complemented with a technical visit to the Hydraulics Laboratory of the Center for Technological Innovation in Construction and Civil Engineering (CITEEC: www.citeec.es), which has an urban block physical model that includes a rainfall-simulator and a complete drainage network. The technical visit is carried out as part of the teaching activities of the subjects Hydraulic Works and Hydrology - of the Master's Degree in Civil Engineering - and Water Supply and Drainage Systems - of the International Master's Degree in Water Engineering -, which are taught at the University of A Coruna. This visit aims to facilitate the understanding of hydrological and hydraulic urban processes. The first problem proposed in this manual, which is usually solved after the visit, consists of the modelling of the laboratory infrastructure, thus improving the understanding of the processes that are modelled with SWMM.

Throughout the text, SWMM model structure is progressively explained allowing students to solve the proposed problems. The aim of the manual is not to provide the theoretical basis of the process of designing sewerage networks, nor to provide a detailed description of all the program options. The text covers only the fundamentals to develop the proposed exercises. Therefore, the manual is intended as a complement to the theoretical bases given during the classes.

A folder containing a SWMM template model is provided for each of the proposed exercises, including a conceptual scheme of the problem and the initial conditions in text format. In addition, the problem solved is also included, so that students can check the results or modify some options of the model and analyse its behaviour.

2 SWMM MODEL

2.1 Introduction

Storm Water Management Model (SWMM) software is a program developed by the US-EPA for urban drainage and sewer systems modelling. SWMM allows the modelling of both hydraulics and pollution generated and mobilised in urban drainage systems, although its stronger capabilities lie in the modelling of the hydrological and hydraulic processes of the network. Pollution build-up and wash-off analysis processes are not so accurately modelled and pollution results show a large degree of uncertainty, so SWMM applications for these purposes are not so conventional.

SWMM first version was developed in 1969 in the United States. Its popularisation began in the 80s with the development of version 4.4. SWMM version 4 worked in an MS-DOS environment in command line format. The program used input files for the different elements of the system and for describing rainfall.

The current version of SWMM, 5.1.xxx, provides a graphical interface user (GUI) that allows users to introduce drainage area data, simulate the hydraulic behaviour of the network, estimate water quality, display all the results with a variety of graphics, and generate output files for further processing with other tools such as spreadsheets. In addition to the visualization of the results as hydrographs, system thematic maps and tables, the software has a very powerful statistical tool that allows, for example, the characterization of the pluviometric regime or the number of overflows or spills from a sewerage network. Furthermore, SWMM v. 5.1.xxx includes LID or SuDS techniques modelling.

SWMM version 5.1.xxx is available in English. There is also a Spanish version of the program developed by the Department of Hydraulic Engineering and Environment of the Polytechnic University of Valencia (UPV). Nevertheless, it is not recommended to use the Spanish version because it has not been updated since 2010.

The most common application of SWMM model is the design of sewage and drainage networks by means of the detailed simulation of a single rain event. Design rainfall is associated with a certain level of risk defined by their return period. The initial approach for designing the urban drainage system based fundamentally on flood criteria has been overcome in recent years. Nowadays, the design of any urban drainage system requires considering two aspects: flood and pollution control design. SWMM is also currently used to evaluate the overall performance of systems attending to the assessment of CSO environmental impact. To evaluate the impacts produced on water bodies during wet weather periods, historical rainfall records have to be used to reproduce the “average” behaviour of the system.

The purpose of this manual is not to describe the theoretical framework for urban drainage design, since these are presented in the theoretical contents of both Master's Degree in Civil Engineering and Water Engineering UDC subjects. Furthermore, it can also be consulted in numerous manuals and technical regulations, such as the

Instructions for Hydraulic Works in Galicia, ITOHG (Augas de Galicia, 2010), which will be used as reference in some sections of this text.

In short, using SWMM we will be able to carry out the following tasks:

- To design the main components of a drainage system for flood control.
- To design different retention or infiltration structures for flood control, hydrological control or pollution control.
- To define strategies for the minimisation of combined sewer overflows (CSO), known as *Desbordamientos de Sistemas Unitarios* (DSU) in Spain.
- To evaluate the impact of sewer infiltration in combined or separate drainage systems.
- To design and evaluate the efficiency of runoff control measures, such as the application of SuDS techniques.

When a bibliographic search of the SWMM model is carried out, numerous references, manuals, scientific works, courses and specialized forums on the application of SWMM can be found. Perhaps the best starting point is the [US-EPA website](#), where the following information is available:

1. The latest software version.
2. Source codes and errors detected in the model. This section is useful if we are interested in developing some new software functionality.
3. SWMM Manuals and Guides, consisting on:
 - User’s manual. Available through the program help.
 - Applications’ manual. This report has a series of applications with solved examples.
 - Reference Manuals (hydrological, hydraulic and water quality reference manuals) describing the algorithms used and how they have been implemented in SWMM.
 - A guide for the simulation of green infrastructure and the application of Geographic Information Systems with SWMM.
4. Other documents. This section provides a link to a community of users who are developing improvements to the model in parallel with the official versions of the US-EPA.

In the following section we provide a brief description of the conceptual model implemented in SWMM to define the sewer system. Then, we present a revision of the main elements of the model and we include a brief overview of SWMM calculation methods. These sections are focused on covering the teaching needs of the subjects taught at the Civil Engineering School of A Coruña, so some elements such as pollution modelling, infiltration or SuDS modelling are not considered in the text.

2.2 Sewer network conceptual model in SWMM

SWMM considers the drainage system as a set of interrelated elements called **objects** that are placed in a series of **layers**. The objects can be *visual elements* (representing a specific feature, such as a manhole) or *non-visual elements* (representing general

properties of the whole system and not displayed in the study area map). Each layer represents a hydrological, hydraulic or pollution processes. The layer structure is accessible from the Project navigation panel of the SWMM interface (Figure 1).

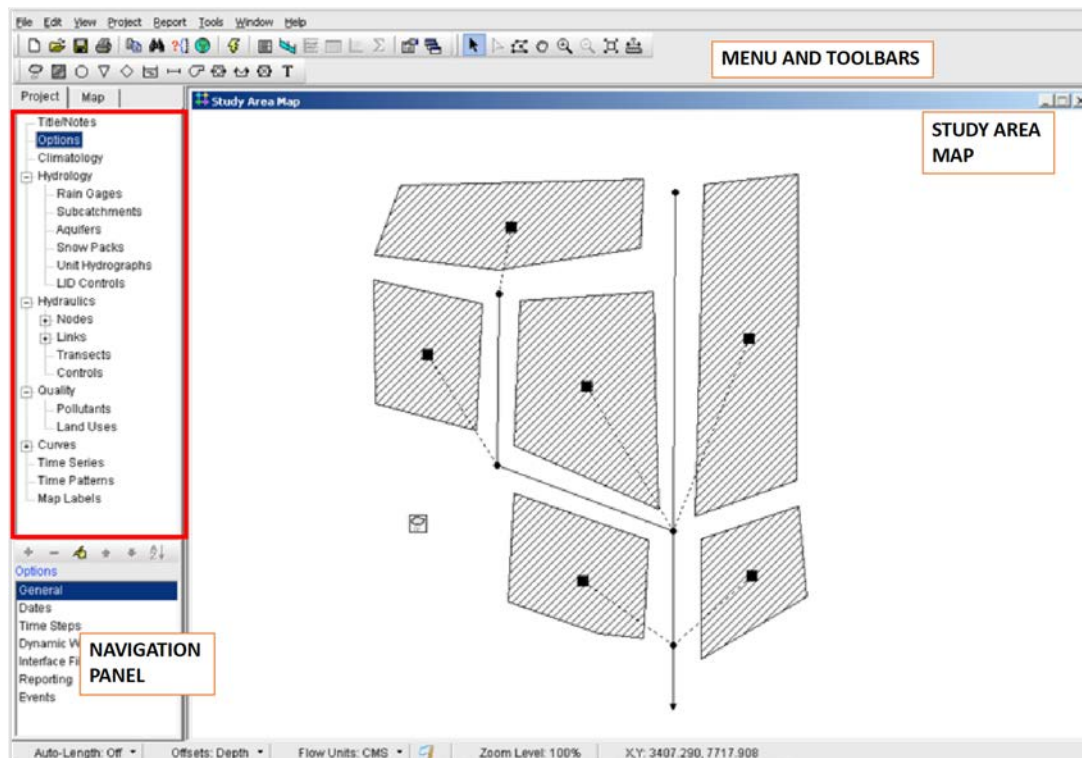

Figure 1. SWMM v5 layers and objects in the graphic user interface.

The main layers of SWMM are the following:

- In **Climatology layer** we define snowmelt-runoff transformation parameters (wind speed, snow melt, air temperature, etc.) and precipitation losses by evapotranspiration. In rainfall design procedures (anti-flood design), it is not necessary to define any parameters in this layer. However, when performing continuous simulations, it is convenient to introduce evaporation ratios (by defining a constant daily value or a monthly variation pattern). Evaporation process allows the impermeable surfaces drying after rainfall episodes, and thus the surface detraction loss is considered in the determination of the net rainfall.
- Two fundamental elements will be introduced into the **hydrology layer** in any modelling of an urban drainage system: *raingages* and *subcatchments*.

Raingages represent rainfall inputs into the model: the total rainfall. The *net rainfall volume* is the portion of the total rain volume that will be transformed into surface runoff in the subcatchments elements. SWMM defines the *net rainfall* as the *total rainfall volume* minus *evaporation*, *surface detraction* and *infiltration*. *Surface detraction* includes interception losses in vegetation and other surfaces such as building facades and surface storage in ground depressions (e.g., street puddles). *Infiltration* shall be considered only in permeable areas of catchments. The proper

definition of subcatchments is perhaps the most important aspect in a SWMM model, since it determines the shape of the hydrographs in wet-weather periods.

More non-visual elements can be defined in the *hydrology* layer such as aquifers, snow packs, or unit hydrographs linked to sewer pipe infiltration-exfiltration, but these are not commonly used in most of the SWMM applications. Finally, some model parameters in LID controls tab shall be included in this layer if we define SuDS techniques in our model.

- In **hydraulics layer** wastewater transport elements are introduced (channels, pipes, pumps and regulation elements) to derive flow discharges to drainage system outlets (e.g., rivers or WasteWater Treatment Plants WWTP) and, where appropriate, storage and treatment units (e.g., stormwater tanks). Flow discharges may have different sources like surface runoff, infiltrations from aquifers, dry weather flows or even user-defined input hydrographs for particular nodes (e.g. if the discharge flow from an upstream basin or the flow from a particular industry is known).

Four different types of elements are included in this layer: *nodes* or punctual elements, *links* or linear elements, user-defined *transects*, and *control rules*. The most frequent elements in drainage system models are point and linear elements. The most common *node* elements are manholes (*junctions*), spills (*outfalls*) and *storage units*, which are used to model for instance, stormwater tanks. The linear elements can be pipes (*conduits*), *pumps*, and discharge and overflow structures, that are defined by using orifice, weir and outlet equations. In order to describe non-standard cross-section shapes for a duct (pipe or channel), *transects* shall be used. Finally, *control rules* allow to introduce operational logic in system elements (e.g., a pump operates if a pre-defined water depth value is reached). *Transects* and *controls* are not described in this manual, but more information can be found in the SWMM User Manual (Rossman et al., 2015).

- In **quality layer**, pollution surface build-up and wash-off processes parameters are introduced by using *pollutants* and *land uses* options.

SWMM also includes another series of complementary layers in which a title and a short description of the simulation can be defined. These are described in the practical exercises. Other complementary elements usually needed in SWMM simulations are: *curves* or relationships between two variables such as rating curves (water depth vs area or volume); *time series*, used for example to define rainfall; *time patterns* and *map labels*.

It's important to note that not all the elements described above need to be included in all SWMM models. For example, if we want to model a separate foul network (without stormwater inputs), we have not to include any *raingage* in the model.

2.3 Main elements of the sewerage systems in SWMM

SWMM 5 represents the elements of drainage systems and the developed hydrological-hydraulic and pollution processes through objects. The program considers two types of objects: (i) visual and (ii) non-visual. Visual objects represent physical processes in the system (e.g., precipitation, runoff, or flow in pipes). Non-visual objects describe some additional elements or processes that are not in the work area. The following are the most common visual and non-visual objects used to solve the problems proposed in this manual. A more detailed description of these objects can be found in the SWMM User Manual (Rossman, 2015) or in the program's own online help.

2.3.1 Visual objects

Figure 2 shows a model of a conventional sewerage network containing its most common elements. The *raingage* and the *subcatchments* are the main objects used for the simulation of the rainfall-runoff transformation. Runoff transport through the drainage network is conducted by manholes (*junction*) and pipes (*links*). The diagram also shows a *storage unit* and two *outfalls*. At the outlet of the stormwater tank there are two control elements. One of them (*outlet*) regulates the flow discharge to the WWTP. The other element is a spillway (*weir*) from which CSO spills are released to aquatic bodies.

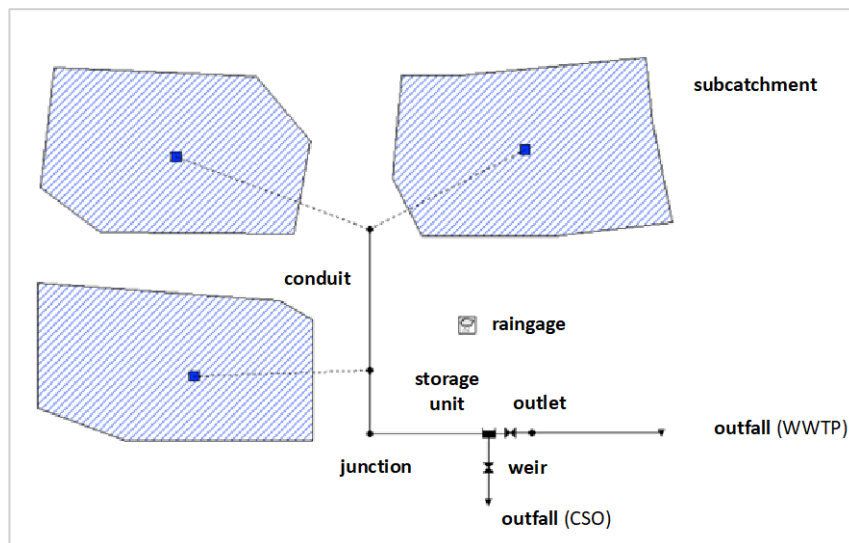

Figure 2. Layout of the visual elements of a conventional sewerage system.

Rainfall input data is defined in the **raingages**. Rainfall data can be defined by the user through a time series (e.g., design hyetograph) or from an external data file. To define design rainfall, ITOGH SAN 1/1- Calculation of flow discharges in sewage systems can be used (Augas de Galicia, 2010). For long-term precipitation series it is recommended to use an external file (see chapter 5).

Subcatchments are hydrological elements of the urban surface whose geometry and drainage system features convey the runoff directly to the network. A typical subcatchment example is a street reach or a roof. Subcatchment discretization is maybe the most important procedure of SWMM modelling. The user is the responsible for

defining homogeneous hydrological areas (e.g., surface roughness or shape) and identifying their outlet. Outlets are typically system *nodes*, which represent the network's manholes or street grates.

Each subcatchment can be split into two different zones with different hydrological characteristics: the impermeable area and the permeable area. Surface runoff ground infiltration occurs in the permeable zones. Several infiltration models are defined in SWMM for these areas. From a practical point of view, the Horton equation is often used to evaluate infiltration in high impervious subcatchments (e.g., greater than 40%). In highly permeable areas, Curve Number method (SCS CN) must be used instead of Horton approach.

Impermeable areas can be further divided into two sub-areas: one that includes a surface storage volume as an initial detraction (e.g., puddles) and another that does not. It is recommended to fix the percentage of the area without depression storage at a zero value.

Finally, runoff from each subcatchment zone can be conducted to another area (e.g., runoff from a green area can be discharged to a road) or, more commonly, it can be connected directly to the outlet node. Details of how SWMM incorporates the modelling of the rainfall-runoff transformation can be found in software Hydrological Reference Manual (Rossman and Huber, 2016).

The model shown in Figure 2 includes drainage network objects. There are several types of punctual or *node* type objects, being the most common *junctions*, *outfalls* and *storage units*.

Junctions are intended to connect linear type elements (*links*). Frequently, *junctions* represent manholes, but they can also be used to model a gully pot or curbs links with the network. In order to define a node, we must introduce at least the height of the bottom and the area of the element. In some cases, we may want to lock manhole cover to avoid flooding. Special watertight cover can be modelled for these purposes defining a *surcharge depth* higher than node maximum depth (*max depth*). SWMM uses open channel flow equations if water depth is lower than pipe diameter, and switches to pressurized-flow equations when the water depth exceeds this threshold.

Time series or time patterns (daily, weekly or monthly) can be introduced into *junctions* to define wastewater dry weather flows. Dry weather discharges must be determined for each node using the population density, surface area and wastewater provision. This procedure can be found at ITOGH SAN 1/1- Calculation of flow discharges in sewage systems (Augas de Galicia, 2010).

Storage units are nodes representing network features with storage capacity. These can be used to model from small storage systems, such as network chambers, to large CSO stormwater tanks. The volume of storage units is defined by means of a tabular relationship of water depth vs surface area, called *storage curve*. In SWMM a storage rating analytical curve can be also used, although storage curves are recommended to avoid errors when introducing the tank geometry.

The **outfall** elements represent in SWMM the terminal nodes of the network, such as sewer spills. Only one *link* element, such as a pipe, can be connected to an *outfall*. In the outfalls, the invert level and the model boundary conditions must be defined. Critical depth, normal depth, a fixed water depth, a tidal table or a time series can be used for the latest purpose, with critical depth condition being the most frequent when no backwater effects are expected.

Regarding *link* type elements, **conduits** are used to represent surface pipes or channels as curbs. It is convenient, but not necessary, to define the conduits from the upstream node to the downstream node.

Conduits are defined by their length, the ID of their initial and final nodes, their cross-section shape, and a series of coefficients to evaluate headlosses. Conduit slope is established in SWMM using inlet and outlet depths. Drop shaft manholes or fall manholes can be defined by indicating *inlet* and/or *outlet offset* values, which represents the shift between manhole bottom and pipe height (see Figure 3).

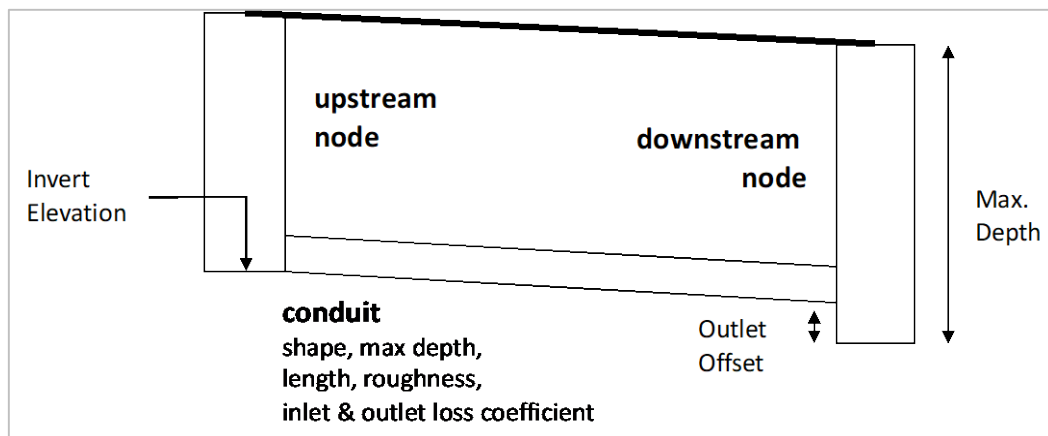

Figure 3. Conduit representation in SWMM.

Regarding the cross-section of the conduits, a predefined catalogue of 21-shape is available in SWMM. By default, circular is the most frequent pipe shape, characterized by their inner diameter (*max depth*). To include several parallel identical pipes, the *barrel* option of *shape* tab can be used.

SWMM allows to introduce major (continuous) and minor (punctual) headlosses. Continuous friction pressure losses are calculated using the Darcy-Weisbach equation by entering pipe Manning roughness coefficient. Minor headlosses at conduit inlets and outlets are defined in the pipe properties tab. Manhole headlosses depend on many factors such as the invert shape, drops and manholes bends. In SWMM, minor headloss coefficients are constant values. Headloss coefficients of 1 and 0.5 are recommended for the pipe inlet and outlet, respectively. These values are on the safety side in most simulation scenarios and assume pressure losses due to sudden contraction and expansion of the streamlines, respectively.

Three different transport flow simulation models are included in SWMM: uniform flow, kinematic wave and dynamic wave. Dynamic wave option must be selected. This approach solves the complete Saint-Venant open channel equations. For pressurized flows, the Priesman slot approximation or a specific formulation developed for the

EXTRAN module of SWMM version 4 is used. These aspects are described in detail in the Hydraulic Reference Manual (Rossman, 2017).

Pumps are *link* elements that allow raising water from lower to higher areas with an adverse hydraulic gradient. Pumps are defined by a *pump curve*. A pump curve describes the relation between a pump's flow rate and the conditions at its inlet and outlet nodes. Different types of pump curves are supported including pump characteristic curve (pump flow-rate vs head), or relationships between pump flow-rate and stored volume or the available height at the initial node of the pump. The on/off status of pumps can be controlled dynamically by specifying startup and shutoff water depths at the inlet node or through user-defined *control rules*.

The flow regulation in node-type elements such as load chambers or tanks can be modelled in SWMM with **flow regulator** link elements. There are three types of regulation elements, which are described in more detail in the Hydraulic Reference Manual (Rossman, 2017) and in the program help option:

- *Orifices* or throttling pipes are drainage elements located in outlet or diversion structures within drainage systems, which are typically openings in the wall of a storage facility or a control gate. Hydraulically, these can function as a free flow pipe or like a submerged orifice. Orifices are defined by the height of their axis, the area and the discharge coefficient. Control rules can be also used to modify their area, allowing to simulate automatic control gates.
- Spillways (*weirs*) are overflow structures located, for example, at CSO spill of a storm tank. There are 5 types of SWMM spillways: transverse, side, V-shaped, trapezoidal and road-type. From a practical point of view, a simple spillway without baffles or screens for floating elements or gross solids control in a stormwater tank should be modelled as *transverse* type spillway with a discharge coefficient similar to sharp-crested weirs. Without considering any corrections for flow submergence, weir discharge coefficient can be set as 1.7. In order to fully define a spillway, crest height, width and the maximum height of the spillway opening are necessary. When a spillway is surcharged, SWMM modifies the spillway equation to orifice equation automatically to compute flow through it.
- *Outlet* type elements are flow control devices typically used to control outflows from storage units. They are used to model special head-discharges relationships that cannot be characterized by *pumps*, *orifices*, or *weirs*. Outlets are defined using a head-discharge type *curve*. Typical examples of this type of *flow regulators* are vortex regulators or complex spillways with rash-tracks or screens. These structures have their head-discharge curve which must be provided by the manufacturer.

Finally, a special type of visual object are the text labels that can be optionally added in the SWMM area map. They are called **map labels** and are used to identify singular elements or regions of the map.

2.3.2 Non-visual objects

Non-visual objects are a series of SWMM properties allowing to parameterize global processes model. The most frequent non-visual objects are: the *climatology* object, used to define evaporation; the *transects* object, which allows the definition of irregular cross sections or cross sections shapes not included in pre-defined SWMM catalogue; or the *control rules*, which consist of rules governing the logical operation of flow regulators or pumps during the course of a simulation. Appendix C.3 of the User Manual (Rossman, 2015) describes in detail the format that these rules must have.

Other non-visual objects used in most simulations are *curves*. These objects define relationships between two variables in a tabular form. There are six types of curves, although the most common are the following:

- *Storage curve*, which describes how a *storage unit* is filled by a surface area vs water depth relationship.
- *Pump curve*, which relates the flow pump-rate with water head and volume according to the type of pump used in the simulation.
- *Rating curve*, which describes head-discharges relationships in outlets.

Finally, *time series* allow to introduce a data series to be introduced or imported in the model, for example, rainfall records or flow rates. Conversely, *time patterns* elements allow introducing the hourly, daily or seasonal patterns of dry weather time discharges into manholes.

3 PERFORMING THE SWMM MODEL OF THE SCIENTIFIC PLATFORM OF URBAN HYDROLOGY TESTS FACILITY

3.1 Description of the Scientific Platform for Urban Hydrology Tests facility

The first example in this manual consists of simulating the drainage system of the Scientific Platform for Urban Hydrology Tests facility (PCEHU) located in the CITEEC Hydraulics Lab. This physical model consists of a street crossing in an urban area on which three different rainfall intensities can be generated (30 mm/h, 50 mm/h and 80 mm/h). Runoff generated on roofs, sidewalks and roads is conducted into a drainage network located at the bottom of the model. Figure 4 shows a series of photographs of the platform, while Figure 5 shows a plan layout of the road surface, which indicates the slopes of the streets and the distribution of the manholes and pipes.



Figure 4. PCEHU main general view (above) and physical model surface and drainage system (below).

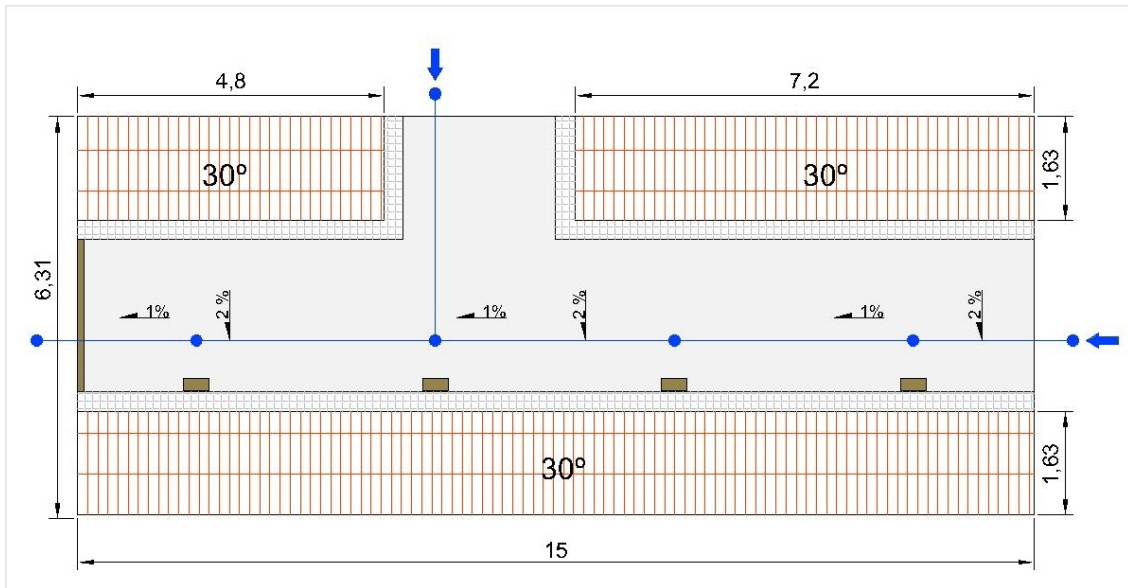

Figure 5. Plan layout of PCEHU surface.

3.2 Problem statement

To develop the SWMM model of the PCEHU, we will need information on the surface catchment, discretize it into different subcatchments and the data related with the properties of the different nodes (manholes, gully pots, regulation control devices, etc.). In addition to the subcatchment and the network topology, it is necessary to include in the model the design rainfall and dry weather flow data.

3.2.1 Subcatchment definition

In the physical model we have 4 gully pots that drain surface runoff from the street surface to drainage network manholes. In order to determine each subcatchment boundaries, we have to consider street surface slopes (2% transversal and 1% longitudinal). In addition, there are four gutters that collect the rain intercepted by the roofs and incorporate it into different manholes. The conceptual model of the network, shown in Figure 6, has a total of 9 sub-basins: 5 street-type and 4 roof-type.

The geometric properties of the different subcatchments and their connectivity with the nodes of the model are shown in Table 1. Complementary data for the definition of the subcatchments are the surface roughness, which will be fixed with a Manning coefficient $n = 0.016$, and the surface depression storage volume, established at 1 mm for all the impermeable surfaces. As the facility is completely impervious, nor non-permeable areas neither infiltration parameters have to be defined.

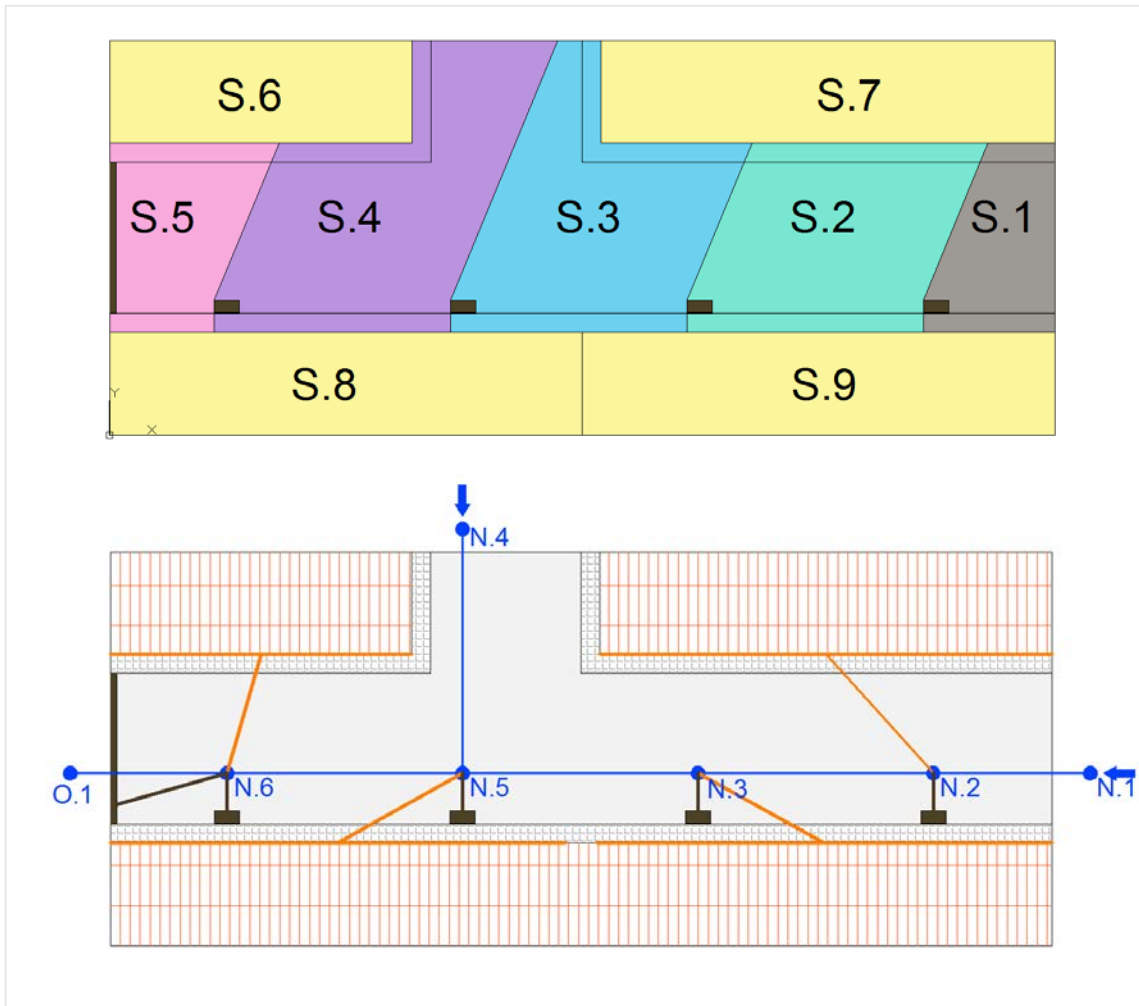

Figure 6. PCEHU facility subcatchment model layout (above) and node definition (below).

Table 1. PCEHU facility drainage model subcatchment properties.

Subcatchment	Outlet node	Area (ha)	Width (m)	Slope (%)	Imperm. (%)
S.1	N.2	0.00050	1.5	2.24	100
S.2	N.3	0.00113	2.5	2.24	100
S.3	N.5	0.00129	2.4	2.24	100
S.4	N.6	0.00145	2.2	2.24	100
S.5	N.6	0.00063	2.6	2.24	100
S.6	N.6	0.00078	4.8	0.01	100
S.7	N.2	0.00117	7.2	0.01	100
S.8	N.5	0.00122	7.5	0.01	100
S.9	N.3	0.00122	7.5	0.01	100

3.2.2 Nodes and conduits

The model includes 6 nodes or manholes, 4 of them connected to model subcatchments, and an outfall downstream, which we will consider to be a free discharge at critical depth (see Figure 6).

The drainage network consists of 250 mm diameter polycarbonate pipes with a Manning coefficient $n = 0.009$. The slope of all pipes is 0.5 %. This slope is defined from the invert depth of the manholes of the main drainage axis (nodes O.1 to N.1). The P.4 pipe, perpendicular to the main axis, is connected to the P.5 fall manhole at a height of 30 cm measured above the manhole invert.

In the model, pressure losses at the entrance and exit of each of the manholes will also be considered. Headlosses will be defined at the entrance and exit of each of the pipes as 0.2 and 0.5 respectively.

Table 2 and Table 3 show the data needed to define model's manholes and pipes.

Table 2. Manhole definition for the PCEHU drainage model.

Manhole	Bottom elevation (m)	Max. depth (m)
N.1	1.081	1.256
N.2	1.069	1.244
N.3	1.050	1.225
N.4	1.351	0.926
N.5	1.031	1.206
N.6	1.013	1.188
O.1	1.000	-

Table 3. Conduits definition for the PCEHU drainage model.

Conduit	Inlet Node	Outlet Node	Length (m)	D (m)
P.1	N.1	N.2	2.50	0.25
P.2	N.2	N.3	3.75	0.25
P.3	N.3	N.5	3.75	0.25
P.4	N.4	N.5	3.90	0.25
P.5	N.5	N.6	3.75	0.25
P.6	N.6	O.1	2.50	0.25

3.2.3 Rainfall

In this example, a 30-minute hyetograph consisting of 6 precipitation blocks with the intensities that can be generated in the physical model will be considered. The hyetograph is presented in Figure 7.

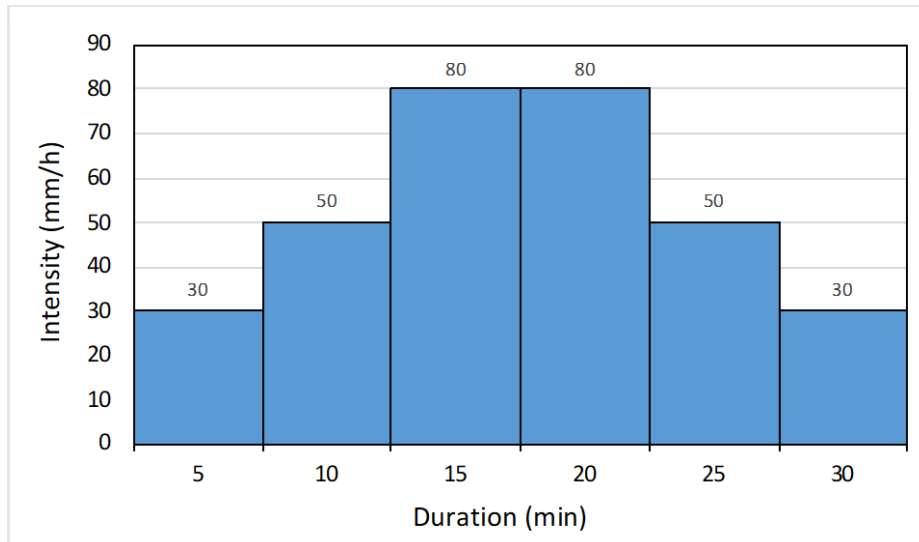

Figure 7. Design hyetograph for the PCHEU drainage model.

3.2.4 Dry weather wastewater flows

Constant dry weather flow rates of 1 and 2 L/s will be entered in manholes N.1 and N.4, respectively.

3.2.5 Results

Once the drainage system is modelled with SWMM, the following results should be obtained:

- Longitudinal profile between nodes N.1 and O.1.
- Flow hydrograph for all the pipes included in the model.
- Pipe velocity map at the worst time of the P.6 pipe (e.g. the simulation time step with higher flow velocity or depth)
- Outfall O.1 rating curve (e.g. flow discharge vs depth relationship).

3.3 Procedure to solve the problem

The steps to follow to develop the drainage model with SWMM will be the following:

- To set up the default properties of the simulation.
- To sketch up the drainage network and the study area.
- To edit the properties of the different model elements.
- To set up simulation options.
- To show the results.

3.3.1 Setting model by-default properties

The first step is to specify the default values of the different element ID and common properties of the visual objects in *Project >> Defaults*.

Figure 8 shows the default options to be included in the model. In the "ID Labels" tab, we will enter the prefixes that we want to use for the numbering of the different elements of the network (for example P. for pipes).

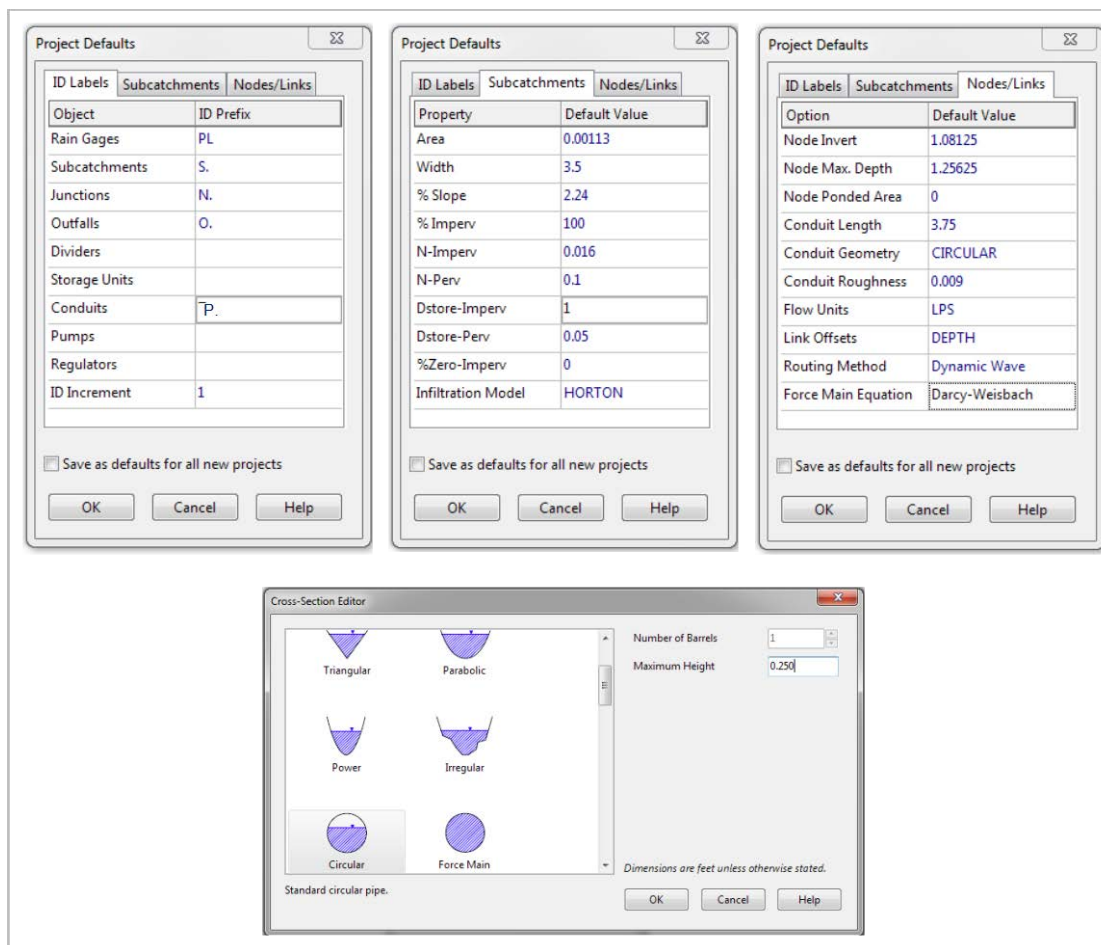

Figure 8. By default simulation options for the PCHEU drainage model.

In the second tab "Subcatchments", the default options for the different subcatchments can be fixed. Some options such as subcatchment area do not make much sense, since each subcatchment will have a different area. Other options such as slope, percentage of imperviousness, depression storage or Manning's coefficient will save time when entering the model data.

The last tab "Nodes/Links" contains manhole and conduits data. Element-specific parameters such as dimensions or lengths will not be very useful, but others such as diameter or Manning's coefficient will allow significant time savings. In addition to the element-specific parameters, this tab contains the *Flow units*, the *Link offsets*, the *Routing method*, and the *Force main equation*.

Regarding the *Flow units*, in this example we will use LPS (L/s), as it is more convenient as it is a very small catchment. In real-world applications we will work usually in CMS (m³/s). Once the flow units are fixed, the remain model units are defined. Thus, if we choose the International Measurement System (SI), the rest of the objects in the model will be defined in SI (for example, the dimensions in m).

The *Link Offsets* option allows to the user to define the elevations reference system used in SWMM in the node-type elements. We can use measurements relative to the bottom or invert of each element -using the option *Depth*- or absolute elevations units referred to a general Datum -using the option *Elevation*-. For example, if a manhole bottom is placed at +10.0 m and the manhole cover is at +12.5 m, to define the manhole coordinate we must indicate it as *Node Maximum Depth 2.5* in relative coordinates (*Link Offsets >> Depth*) or 12.5 in absolute coordinates (*Link Offsets >> Elevation*).

Routing Method and *Force Main Equation* options of the "Nodes/Links" has to be set always with the *Dynamic Wave* and *Darcy-Weisbach* options respectively.

Finally, if we want to fix these default options for future model, we must check the *Save as default for all new projects* option.

3.3.2 Drainage network and study are sketch up

The network will be schematized from the images (.jpg) provided in this example (see Chapter 6). The *Auto-Length* option in the lower toolbar will be activated first. This tool allows to the objects, subcatchments and pipes drawn in the study area, to acquire the areas and lengths directly from the sketch we load in the study area. If *Auto-Length* option is switched-off, the sketch will be merely indicative and all the areas and distances of the model will have to be entered by hand.

Once the *Auto-Length* option is activated, the street layout file corresponding to the image *Block_network.jpg* will be loaded from *View >> Backdrop >> Load (Image File)* menu.

Then, we have to define the dimensions of the backdrop in order to use it as a drawing template and set the drainage systems areas and lengths automatically. We need to introduce the lower left and upper right coordinates of backdrop using the menu *View >> Backdrop >> Resize* (Figure 9). The corner coordinates of the example image are (0.0) and (19.10). By selecting *Scale Map to Backdrop Image*, the dimensions in the study area are adjusted to the backdrop image dimensions.

Before starting to sketch up the drainage system it is strongly recommended to check again if *Auto-Length* is enabled.

An introduction to sewer network design using SWMM

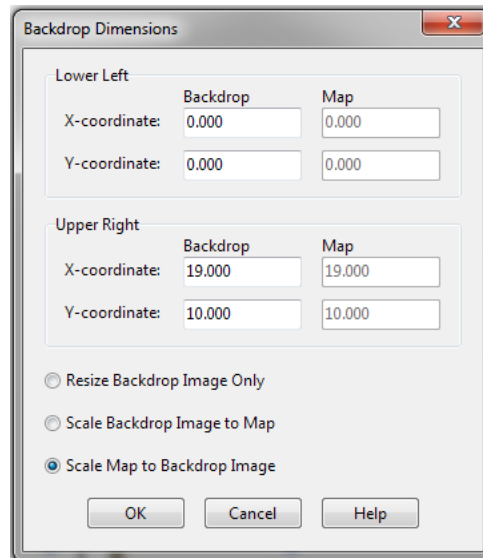

Figure 9. Backdrop dimensions setup for the PCHEU drainage model.

Now, we can define the drainage system model using the backdrop as a template, starting from the nodes, outfalls and pipes. Each type of object is selected in the *Objects toolbar*, which is the toolbar placed at the top of the study area, and then is drawn in the study area. It is recommended to follow the order of the objects indicated in Figure 10. Then, we can introduce model pipes, which should be drawn from the upstream node to the downstream node to avoid confusion when entering the model data.

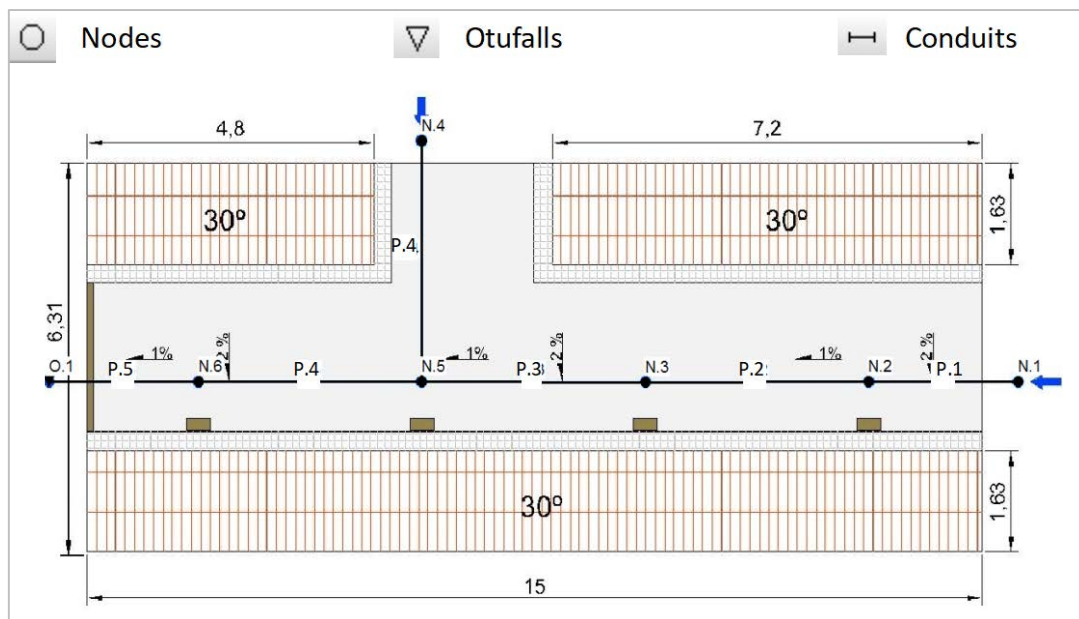

Figure 10. Distribution of nodes and manholes in the PCHEU drainage model.

To display the labels (ID) of the nodes, pipes and other visual elements of the study area, we have to indicate the elements to be displayed using the *Annotation* option in *Tools >> Map Display Options* menu. In *Map Display Options window*, other display options can also be adjusted, such as the borders and shading of the subcatchments, line thickness, the size of the nodes, font size of the annotations, or even indicate with an arrow conduit flow direction.

Once drainage system topology is entered in the study area, the subcatchments shape will be introduced in the model. First, we will change the backdrop using *Block_subcatchment.jpg* file. First, the previous image must be unloaded using *View >> Backdrop >> Unload* menu. Then, we load the new image with the option *View >> Backdrop >> Load (Image File)*. The model subcatchments will be drawn based on the new backdrop (Figure 11). Once all the subcatchments have been entered, backdrop image can be unloaded. Finally, a raingage is placed at any point of the study area.

To prepare backdrop images for modelling, it is recommended to use some CAD or SIG tool that allows us to activate and deactivate the layers with the information of our drainage system. For example, a satellite or a street map can be used for the backdrop. To this backdrop image it will be possible to incorporate the layout of the subcatchments, pipes and manholes. The backdrop images can even include some text data to help identify the drainage elements or define them (for example, the material and diameter of the pipes, or the manhole depth). It is important that all images have exactly the same dimensions, allowing to be exchanged, as in this example.

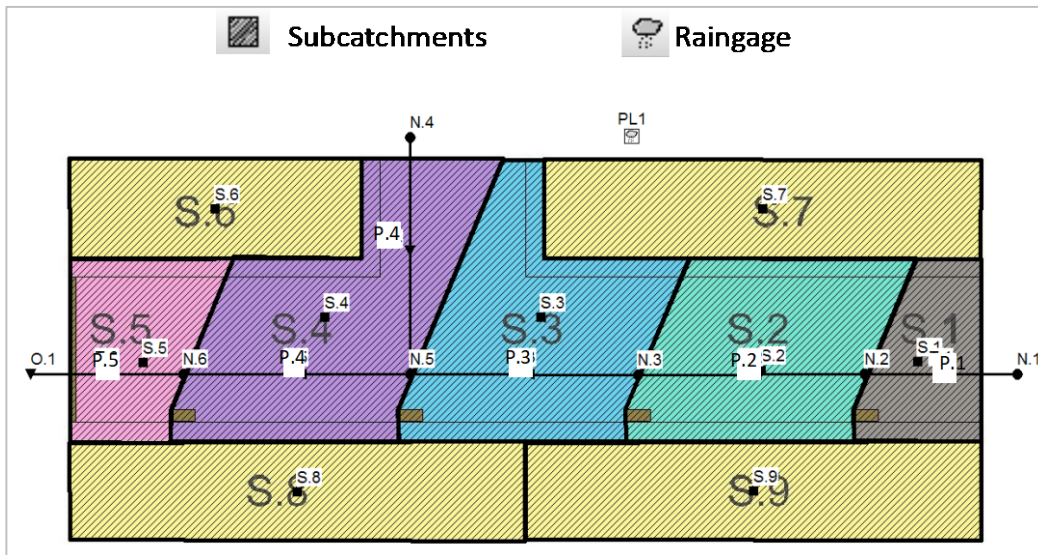

Figure 11. Distribution of subcatchments in the PCHEU drainage model.

3.3.3 Editing object properties

Once all the elements of the model have been introduced in the study area, the next step is to assign the properties of each object. The properties window is opened by double-clicking on each object or by selecting the object in the navigation panel on the left of the SWMM interface. As an example, Figure 12 shows the properties of a sub-basin (S.1), a manhole (N.2) and a pipe (P.3).

An introduction to sewer network design using SWMM

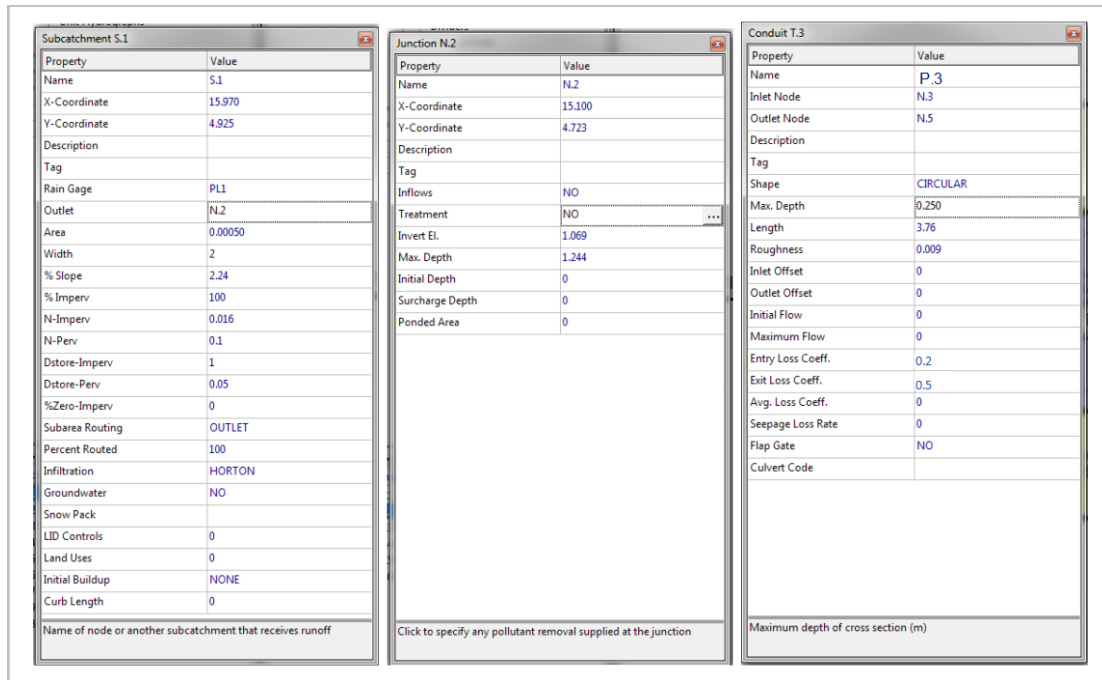

Figure 12. Edition of the properties of the objects of the PCEHU drainage model.

In pipe P.4, it is necessary to define, in addition to its main characteristics, an *Outlet Offset* of 0.3 m, since the pipe is connected to a fall manhole. In the remaining pipes of the model, the *Outlet Offset* is set to zero since they are connected to the invert manhole.

In nodes N.1 and N.4, the dry weather flow must be incorporated in the *Inflows option*, with a value of 1 and 2 L/s respectively (see Figure 13).

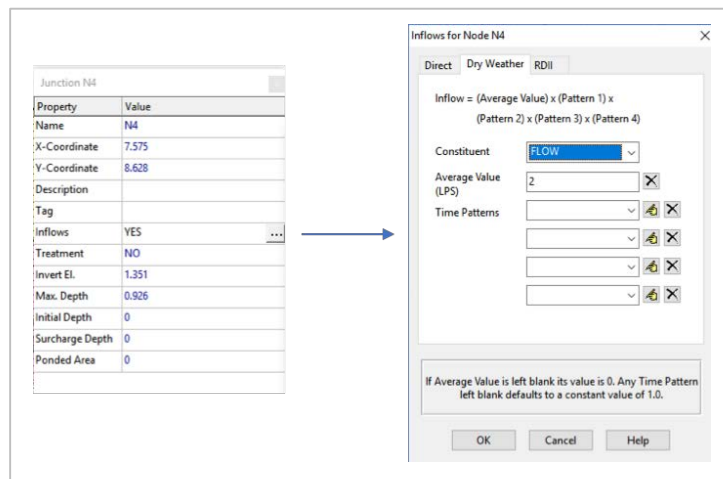

Figure 13. Edition of the dry weather flow options of the PCEHU drainage model.

Finally, the precipitation record must be defined in the raingage. Rainfall data can be imported using an external text file or using a *Time Series* defined in the navigation panel (Figure 14). The first method is highly recommended for long data series (Chapter 5). In this example the second method will be used, defining a time series that is then assigned to the raingauge indicating precipitation format (in this case intensity in mm/h), the time interval (5 minutes) and the origin of the data, which is a *Time Series*.

An introduction to sewer network design using SWMM

The image shows two windows from the SWMM software. The left window, titled 'Time Series Name', has a text field for the name (containing 'Lluvia') and a description field. Below these are checkboxes for 'Use external data file named below' (unchecked) and 'Enter time series data in the table below' (checked). A note states 'No colons means times are relative to start of simulation.' Below this is a table with three columns: 'Date (MM/DD/YY)', 'Time (H:MM)', and 'Value'. The table contains five rows of data. To the right of the table are 'View', 'OK', 'Cancel', and 'Help' buttons. The right window, titled 'Rain Gage PL1', is a property window with a table of 'Property' and 'Value'. The properties include Name (PL1), X-Coordinate (11.270), Y-Coordinate (8.623), Description, Tag, Rain Format (INTENSITY), Time Interval (0:05), Snow Catch Factor (1.0), Data Source Factor (TIMESERIES), TIME SERIES: (with a sub-property - Series Name: Lluvia), DATA FILE: (with sub-properties - File Name: * and - Station ID: *), and - Rain Units: IN. A note at the bottom says 'Data recording time interval at rain gage'.

Date (MM/DD/YY)	Time (H:MM)	Value
	L:05	30
	C:10	50
	L:15	80
	C:20	80
	L:25	50
	C:30	30

Property	Value
Name	PL1
X-Coordinate	11.270
Y-Coordinate	8.623
Description	
Tag	
Rain Format	INTENSITY
Time Interval	0:05
Snow Catch Factor	1.0
Data Source Factor	TIMESERIES
TIME SERIES:	
- Series Name	Lluvia
DATA FILE:	
- File Name	*
- Station ID	*
- Rain Units	IN

Figure 14. Rainfall data input into the PCEHU drainage model.

3.3.4 Analysis and simulation options

Before running the simulation, some analysis options must be specified. To do so, the option *Options >> General* option in the side navigation panel must be selected. For this example, the options shown in Figure 15 will be used.

The options on the *General* tab allows to indicate the model processes to be simulated and the calculation methods. None of the options on this tab need to be changed, as they have been previously defined in the default options.

In the *Dates* tab, the Start analysis date of the simulation, the date from which the results should be displayed and the date of the end of the simulation are indicated. As rainfall data series does not have any defined date in MM/DD/YY format, only the start and end time of the simulation is relevant.

The *Time Steps* tab shows the time interval between results (5 minutes is a common value) and the time step intervals for dry and wet weather calculus. The *Routing* option defines the time step to perform pipe flow discharge modelling. Finally, in the *Dynamic Wave* tab, the options for the flow simulation in dynamic wave are indicated. In this tab, the options indicated in Figure 15 must be chosen for this problem.

An introduction to sewer network design using SWMM

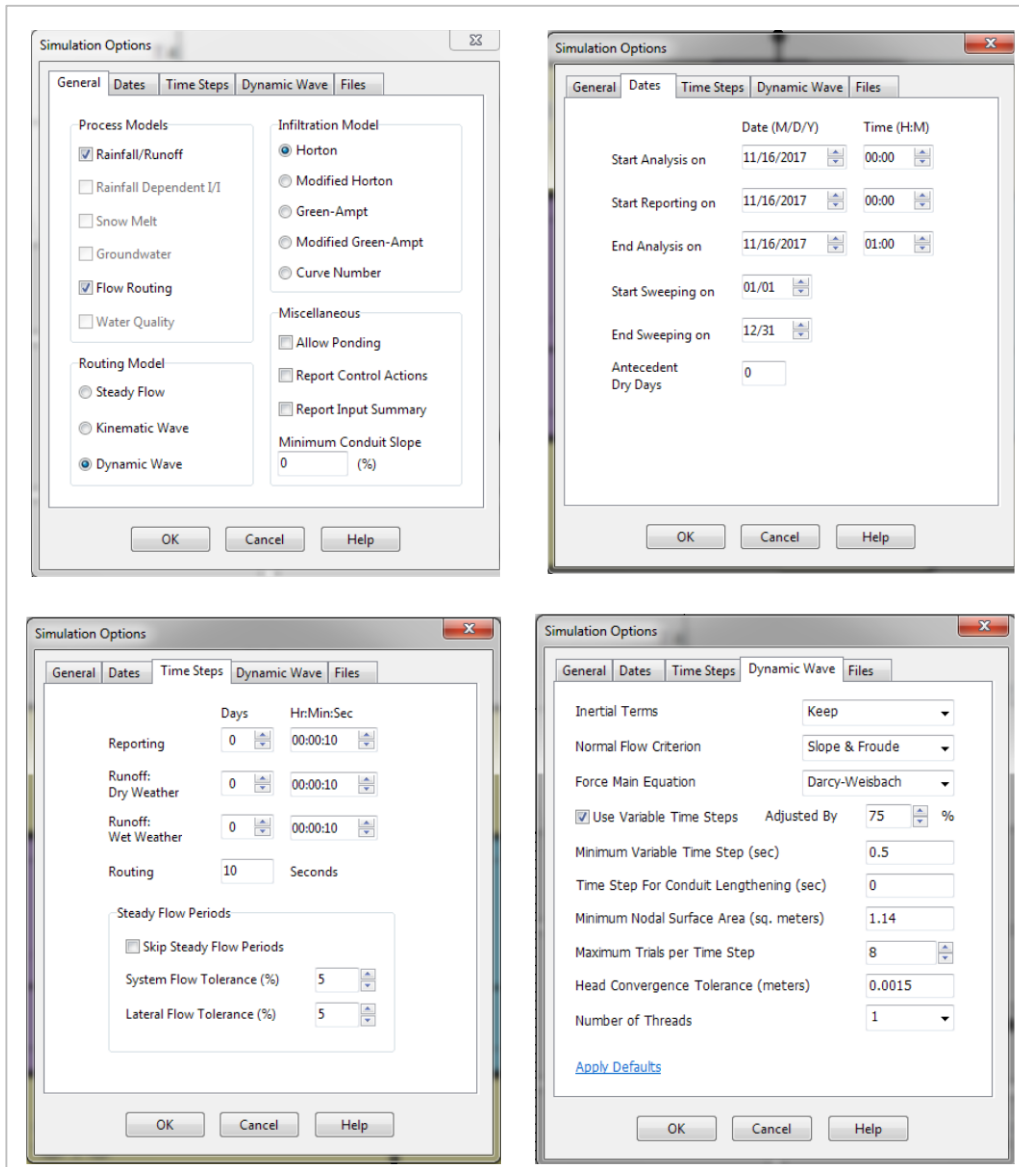



Figure 15. Simulation options in the PCEHU drainage model.

Once all the options have been entered, all that remains is to carry out the simulation. To do so, select *Project >> Run Simulation* from the main menu, or click on the icon with a lightning bolt . A window will then appear informing that the models has been successfully ran and showing model continuity errors, which are typical of the numerical methodology on which SWMM is based. If any of the continuity errors is greater than 5%, this usually indicates that the model is being flooded. This can be corrected by modifying the geometry of the network.

Sometimes, a problem may arise in the simulation due to an inappropriate definition of the drainage system. This occurs for example if an object has not been defined correctly, if there are errors in the model discretization or if there are errors reading input files. In this case, the program would show a message indicating the type of problem. We can look for the error code in the program's help or even in a web browser to solve it.

3.4 Model results

In order to analyse model results, the first option included in SWMM is the *Status Report*, which provides a practical summary of the main results of the simulation. The *Status report* is available at the main menu *Report >> Status*. This report allows searching for the nodes or conduits that present more numerical errors for their later resolution.

In addition to the Status Report, in the report menu the *Status Summary* can be consulted in *Report >> Status Summary*. This report includes detailed information of the different elements of the model. For example, it is possible to look for surcharged or flooded nodes, the time in which the highest velocity is recorded in each pipe to check if it is admissible, or to quantify the overflow volume to the aquatic media in outfall nodes.

Another way of visualizing results is through graphics. SWMM allows to plot three different types of graphs in the menu *Report >> Graph*. These plots can also be created with toolbar icons.

The *Profile Plot* option or icon  allows to plot longitudinal profiles of the water elevation in the drainage network. To visualize pipe water filling and emptying, the animation toolbar found in the *View/Map* option of the navigation panel can be used.

To represent the network profile between the O.1 discharge point and the N.1 node, select the *Profile Plot* option, then introduce the start node and the end node of the profile and select the *Find Path* option. This allows SWMM to add the pipes to the profile plot. Figure 16 shows the profile plot obtained.

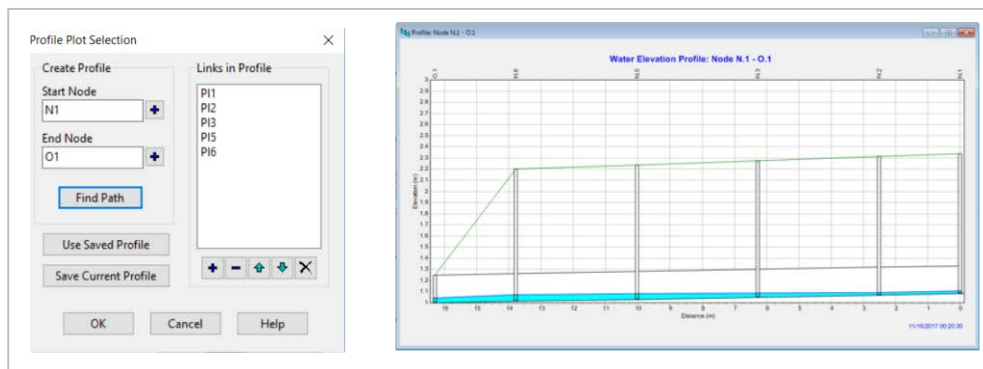



Figure 16. Profile plot between nodes N.1 and O.1 of the PCEHU drainage model.

To represent time series as hydrographs, we must use the *Time Series Plot* option or the icon . In the *Time Series Plot Selection* window, add the variables and elements that you want to represent using the Add option and, once the selection is finished, press *OK*. Figure 17 shows the variable selection windows and the figure obtained with the hydrographs of all the pipes of the PCEHU model.

An introduction to sewer network design using SWMM

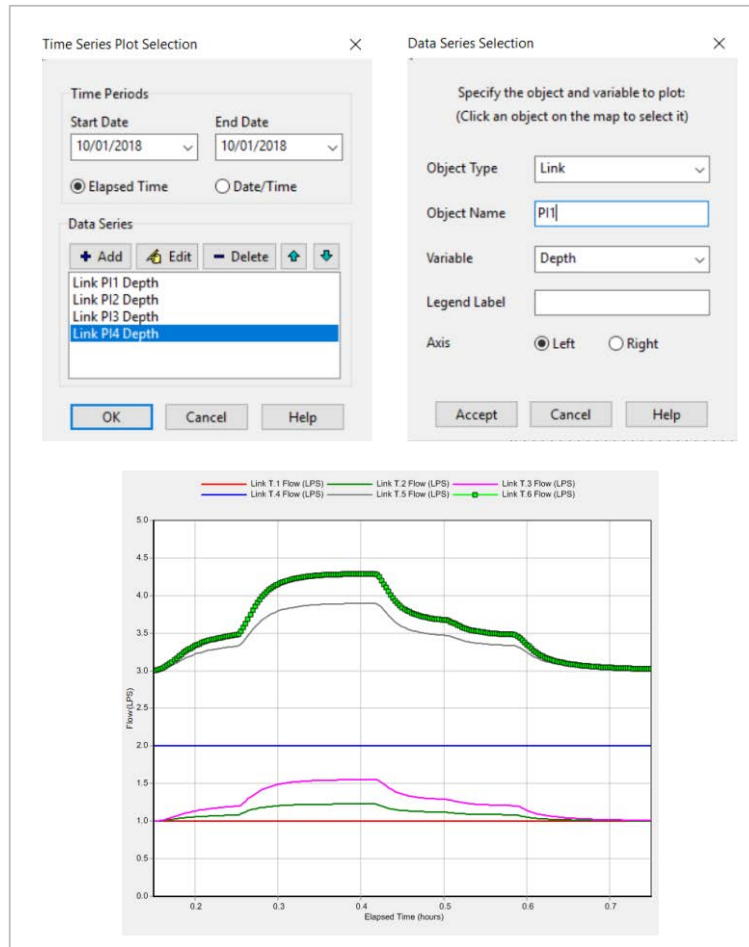



Figure 17. Time series plot window option to display the hydrographs of all pipes in the PCEHU drainage model.

The third SWMM plot option allows to represent scatter plots of two variables by means of the *Scatter Plots* option or the icon . The example in Figure 18 shows the window for choosing the variables for the scatter plot and the discharge curve at the discharge point O.1.

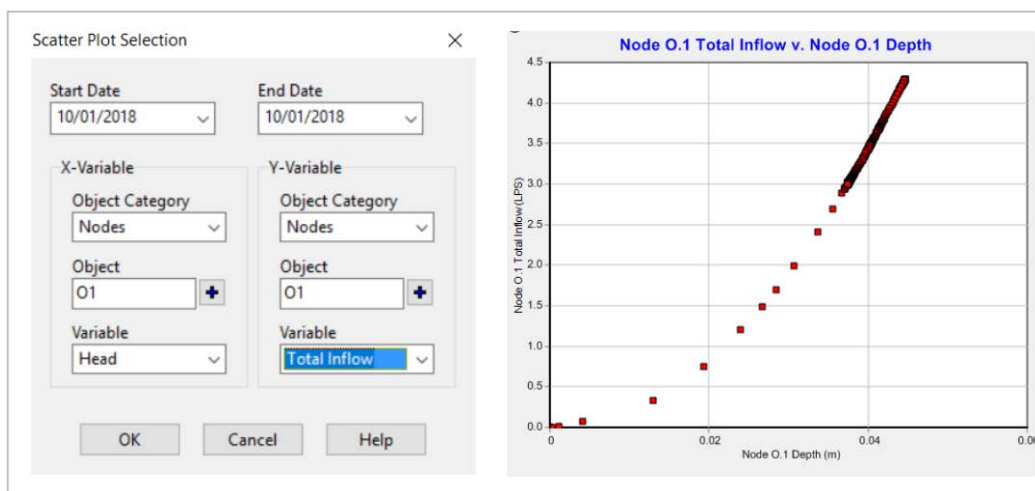

Figure 18. Scatter plot window options to create a flow head-discharge curve in the outfall node of the PCEHU drainage model.

Some SWMM graphics options allow to modify the basic plots shown before, such as adding a figure legend, including secondary axes or defining the names of the variables. However, it is convenient to use some external software such as a spreadsheet to obtain improved graphics. The results can be exported in table format, using the menu option *Report >> Table*. SWMM produces two types of tables: *By object* and *By variable*. In a *By object* table, several properties of one selected object are displayed, such as velocities and flows of a pipe. A *By variable* table allows to show the properties or records of one variable in several elements. This option is useful, for example, to display the flow rate of several pipes in the network.

SWMM version 5 also incorporates a new way of visualizing the results on the *Study area map*, which consists of showing the different ranges of values that a certain variable reaches at a fixed reporting time-step of the simulation using a colour code. Using the *Map* tab of the *Navigation panel*, we can select the variable to be displayed for each type of model object. Then, we can select the reporting time-step by moving the cursor under the *Time* bar. As an example, Figure 19 shows the runoff in each subcatchment, the water depth in the manholes of the model and the pipe flow velocity. It is possible to display also physical parameters of the model elements, such as the subcatchment area or pipes diameters, or model variables, such as elevations or flow-discharges. The colour-map scales can be modified in the study area map by right-clicking on the legend of each variable.

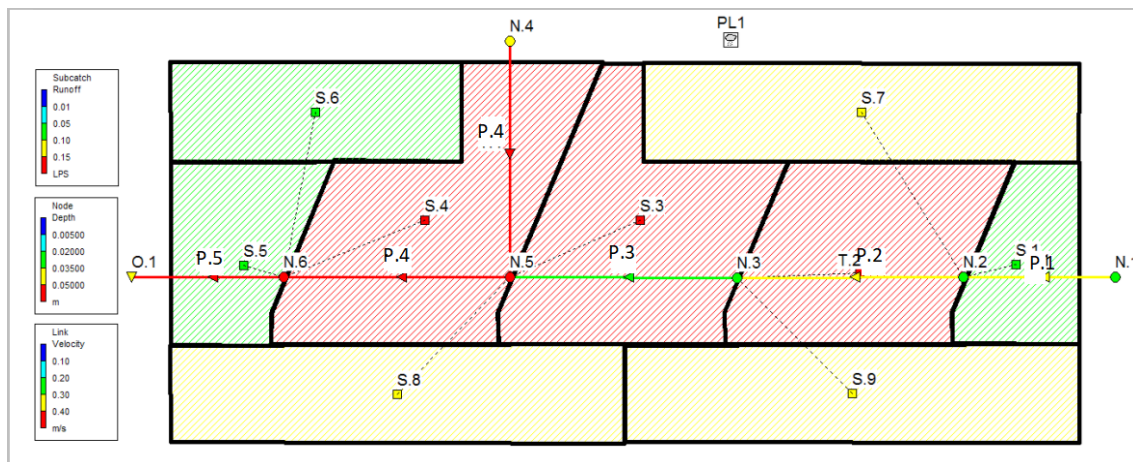



Figure 19. Example of the map display with the variables subcatchment runoff, node water depth and pipe flow velocity.

Finally, SWMM allows to create a powerful statistical report of the model results using the icon . This report is especially useful for long-term simulations, such as months or years. More details will be provided at Chapter 5.

4 SIMPLIFIED COMBINED SEWER NETWORK MODELLING

4.1 Problem statement

In this section, a simplified combined sewer network will be modelled. An urban catchment has been discretized using 6 subcatchments connected to the manholes of a drainage system. Figure 20 shows the catchment layout. Subcatchments, manholes and pipe model properties are presented in Table 4, Table 5, and Table 6.

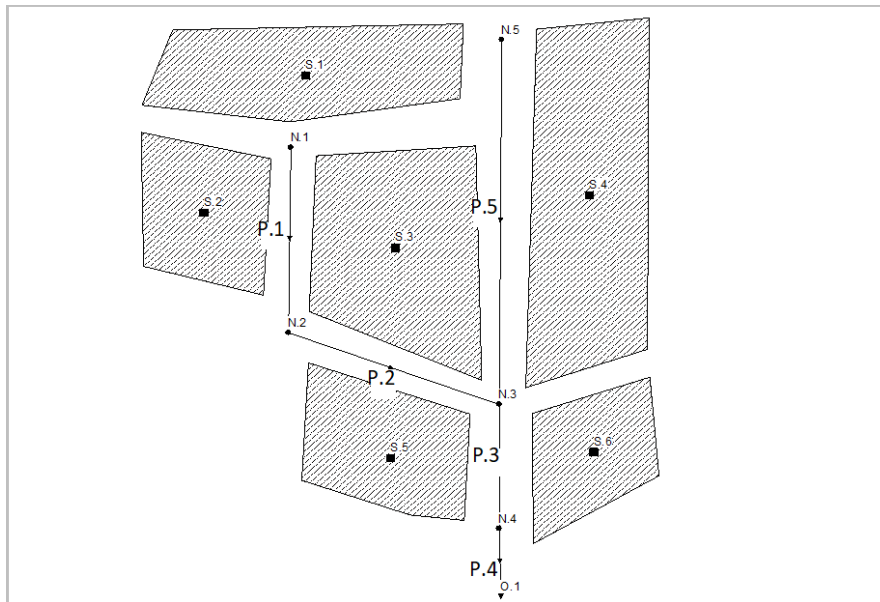

Figure 20. Combined sewer network model layout.

Table 4. Combined sewer network model subcatchment properties.

Subcatchment	Outlet node	Area (ha)	Width (m)	Slope (%)	Imperm. (%)
S.1	N.1	10	500	2	60
S.2	N.2	8	900	6	75
S.3	N.3	9	225	4	80
S.4	N.3	12	240	5	20
S.5	N.4	6	200	1	75
S.6	N.4	5	200	3	80

Table 5. Manhole definition for the combined sewer network model.

Manhole	Bottom elevation (m)	Max. depth (m)
N.1	14.5	2.5
N.2	13.9	2.5
N.3	6.9	2.5
N.4	0.15	2.5
N.5	7.9	2.5
O.1	0	2.5

Table 6. Conduits definition for the combined sewer network model.

Conduit	Inlet Node	Inlet Node	Length	D (m)
P.1	N.1	N.2	500	0.8
P.2	N.2	N.3	900	0.8
P.3	N.3	N.4	225	1.5
P.4	N.4	O.1	240	1.5
P.5	N.5	N.3	200	1

In addition to Table 4 data, the Manning roughness coefficients are needed to define the subcatchments. For impermeable and permeable areas $n = 0.025$ and $n = 0.15$ will be adopted, respectively. The value of the initial depression storage has been estimated at 1 mm and 2 mm for impermeable and permeable areas respectively. The Horton equation will be used to model the infiltration with the following parameters: maximum infiltration capacity of 75 mm/h, minimum infiltration capacity of 25 mm/h, and decay and infiltration coefficients of 0.001. The influence of the infiltration parameters on the simulation will be reduced since the catchment is eminently impermeable.

An important set of parameters governing the hydrological response of the subcatchments are their width and slope. Thus, the greater the slope and width, the higher the runoff peak. Conversely, subcatchments with a lower slope and smaller width will cause lower peak discharges and more time to peak flow. Runoff volumes will be defined by the impervious area of the drainage area and their depression storage volume. To adequately represent the hydrological behaviour of urban drainage systems, we have to set carefully these governing model parameters. In this sense, it is recommended to define homogeneous subcatchments with homogeneous widths and slopes. For example, subcatchments can be defined as street reaches and roofs of each urban block.

Urban catchments can also be discretized by using semi-distributed subcatchments such as those presented in this example. In order to carry out this network conceptualization work, it is recommended follow the procedures defined in the SWMM Hydraulic Reference Manual (Rossman and Huber, 2016) or in the Monographic Book on stormwater management published by several members of the Water and Environmental Engineering Group (GEAMA; Puertas et al., 2005).

In the urban drainage system defined in this example, the shape and geometry of the elements of the model are already pre-established and it is not necessary to define the conceptual model of the network. We have just to introduce the elements already defined in SWMM software.

Regarding the definition of the manholes, data presented in Table 5 is needed. In addition, in manhole N.5 a constant flow rate of 200 L/s must be entered. The discharge point O.1 represents the connection of the catchment to a big sewer truck. Critical depth boundary conditions will be considered.

The drainage network consists of circular concrete pipes with a Manning coefficient $n = 0.015$. In this section, no head-losses will be considered in the manholes. Head-losses will be

added in the following example, where an CSO tank will also defined downstream of the catchment (Chapter 5).

The rainfall profile used in this example corresponds to the Example 7 of *ITOHG SAN 1-1* (Aguas de Galicia, 2010). The design rainfall has been calculated using the Intensity-Duration-Frequency curves (IDF) from the Spanish road regulations IC 5.2 and with the daily precipitation volumes recorded at AEMET's A Coruña weather station. The 1-hour design hyetograph has been defined using the alternating block method for a 10-year return period and by averaging the two maximum rainfall blocks. The obtained hyetograph is shown in Figure 21. Considering this return period, the network design is being carried out to limit the pipe filling ratio to a maximum depth-diameter of $y/D = 0.75$.

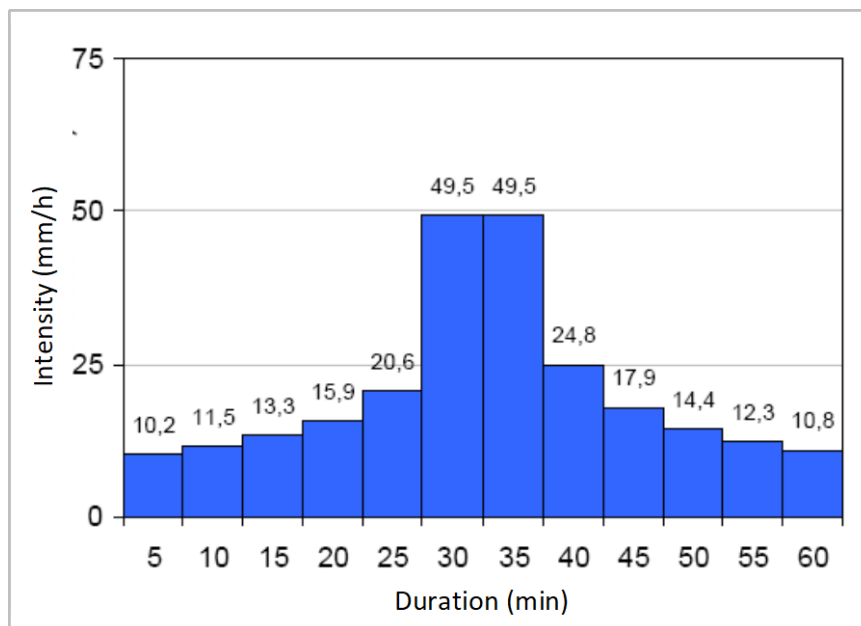

Figure 21. Design histogram for $T=10$ years and 1 hour duration used in the combined sewer network model.

Once the network has been simulated using the previous design rainfall, the following tasks will be carried out:

- To check the hydraulic behaviour of the drainage network: flooding analysis and compliance with the maximum filling-ratio ($y/D < 0.75$).
- To adjust the network to avoid flooding issues.
- To perform a hydrograph plot of P1 to P5 pipes.

4.2 Procedure to solve the problem

The steps to develop the drainage model with SWMM will be the following:

- To determine the default properties of the visual objects.
- Outline the network and the study area: plotting subcatchments, nodes and pipes.
- To edit the properties of the different model elements.
- To set up simulation options and run the model.
- To show the results.

4.2.1 Model by default properties

The by default properties of the elements and subcatchments are defined in the *ID Labels* tab of the *Project >> Defaults* menu option. The prefixes of the visual objects are set as shown in Figure 22. The default properties of the subcatchments, nodes and pipes are then set in *Subcatchments* and *Nodes/Links* tabs. In this case, cubic meters per second (CMS) are used as the default units.

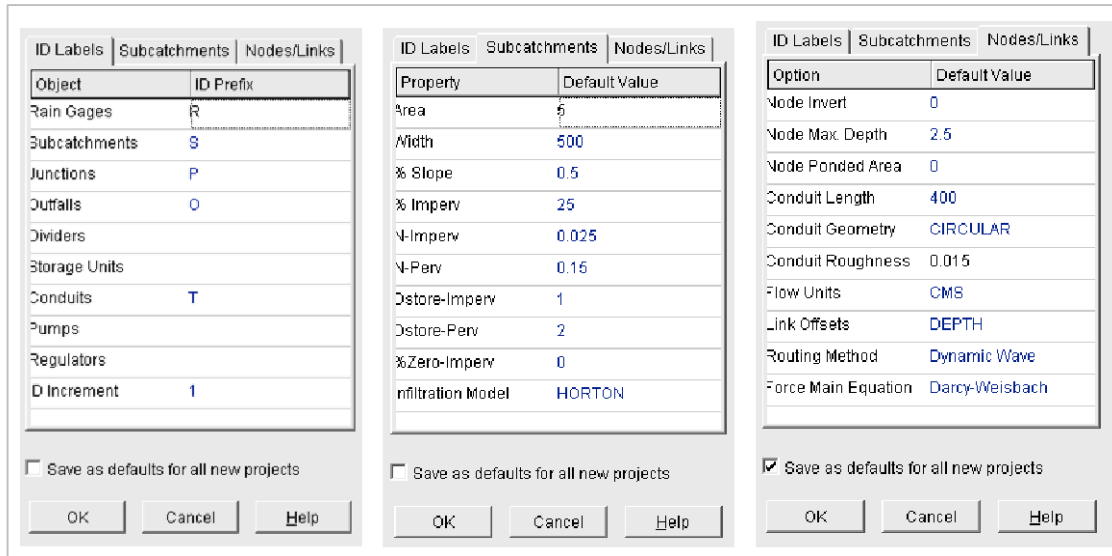

Figure 22. Edition of the default properties of the objects of the combined sewer network model.

In order to provide an adequate numerical precision of the CMS, the numerical accuracy properties should be reviewed. On the *Numerical Precision* tab of the *Tools >> Programs Preferences* menu, three decimal places must be set for the flow data as shown in Figure 23.

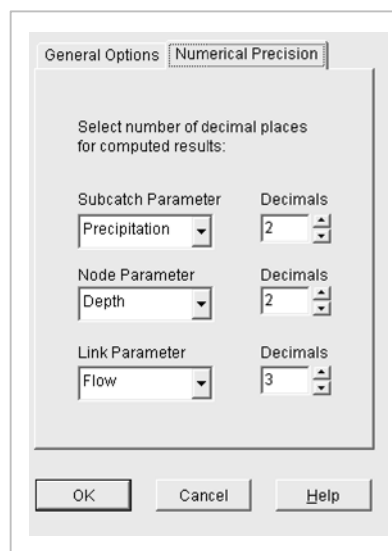







Figure 23. Edition of the Numerical Accuracy of Objects in the model.

4.2.2 Drainage network and study area sketch up

The next step is to plot the layout of the model with its subcatchments, nodes and pipes in the *Study area map*.

Before starting to plot the elements of the model, the image of the study area and the network will be uploaded as backdrop. The backdrop image corresponds to the file *Combined_sewer.jpg*. To load it, use the option *View >> Backdrop >> Load (Image File)* menu. In this example, the backdrop image is provided without any scale and thus will only be used to facilitate the network outline processes. The option *Auto-Length* on the lower toolbar must not be activated and the elements will be plotted in an approximate way, since the area and length properties will be entered numerically.

The icons on the *Objects Toolbar* are used to plot the network elements. First, the subcatchments are drawn by clicking on the icon . The elements will be introduced following the order defined in Figure 20. Then, manholes can be plotted using the icon , and the outfall using the icon . Finally, the pipes are drawn using the icon , always following the direction from the upstream node to the downstream node. The last element to be included in the network drainage model is a the raingage, which is inserted with the icon .

Once the elements of the combined drainage model have been plotted, the backdrop image can be unloaded using the menu *View >> Backdrop >> Unload*.

4.2.3 Editing object properties

The properties of the elements in the model must be changed in the properties window of each object, either by double-clicking with the left mouse button or by selecting the object in the navigation panel. Figure 24 shows, as an example, the properties of subcatchment S.1 and node N.5. In node N.5, a dry weather flow rate of 200 L/s must be introduced using the *Inflows* pop-up window.

An introduction to sewer network design using SWMM

Property	Value
Name	S.1
X-Coordinate	2919.158
Y-Coordinate	8139.535
Description	
Tag	
Rain Gage	PL1
Outlet	N.1
Area	10
Width	500
% Slope	2
% Imperv	60
N-Imperv	0.025
N-Perv	0.15
Store-Imperv	1
Store-Perv	2
%Zero-Imperv	0
Subarea Routing	OUTLET
Percent Routed	100
Infiltration Data	HORTON
Groundwater	NO
Snow Pack	
LID Controls	0
Land Uses	0
Initial Buildup	NONE
Curb Length	0
N-Perv Pattern	
Store Pattern	
Infil. Pattern	
Optional monthly pattern that adjusts depression storage	

Property	Value
Name	N.5
X-Coordinate	5529.801
Y-Coordinate	8697.572
Description	
Tag	
Inflows	YES
Treatment	NO
Invert El.	7.9
Max. Depth	2.5
Initial Depth	0
Burcharge Depth	0
Ponded Area	0
Click to specify any external inflows received at the junction	

Direct Dry Weather RDII

Inflow = (Average Value) x (Pattern 1) x
(Pattern 2) x (Pattern 3) x (Pattern 4)

Constituent: FLOW

Average Value (CMS): 0.2

Time Patterns:

 ↕ ✕

 ↕ ✕

 ↕ ✕

 ↕ ✕

If Average Value is left blank its value is 0. Any Time Pattern left blank defaults to a constant value of 1.0.

OK
Cancel
Help

Figure 24. Editing object properties in the combined sewer network model. An example of the properties set for subcatchment S.1 and node N.5. is shown.

Lastly, the rainfall record in the raingage is defined. For the resolution of this example, the file *rain_T10.dat* is provided with the design hyetograph. Rainfall must be entered using a user-defined *Time Series*. A new *Time Series* is created in the *Project panel* using the "+" button. The option *Use external data file named below* is checked and then *rain_T10.dat* file is imported as shown in Figure 25.

In the *Times series* windows there is also an option to copy and paste the rainfall record from a text file or a spreadsheet. The option *Enter time series data in the table below* should be selected and by positioning the mouse on the first *Time (H:M)* cell, paste the values by right clicking. This option is more convenient since with the *View* button in the *Time series* window it is possible to check if SWMM recognizes the time series.

The last step is to edit the PL1 *raingage* option by defining the source and characteristics of the rain data, as shown in Figure 25.

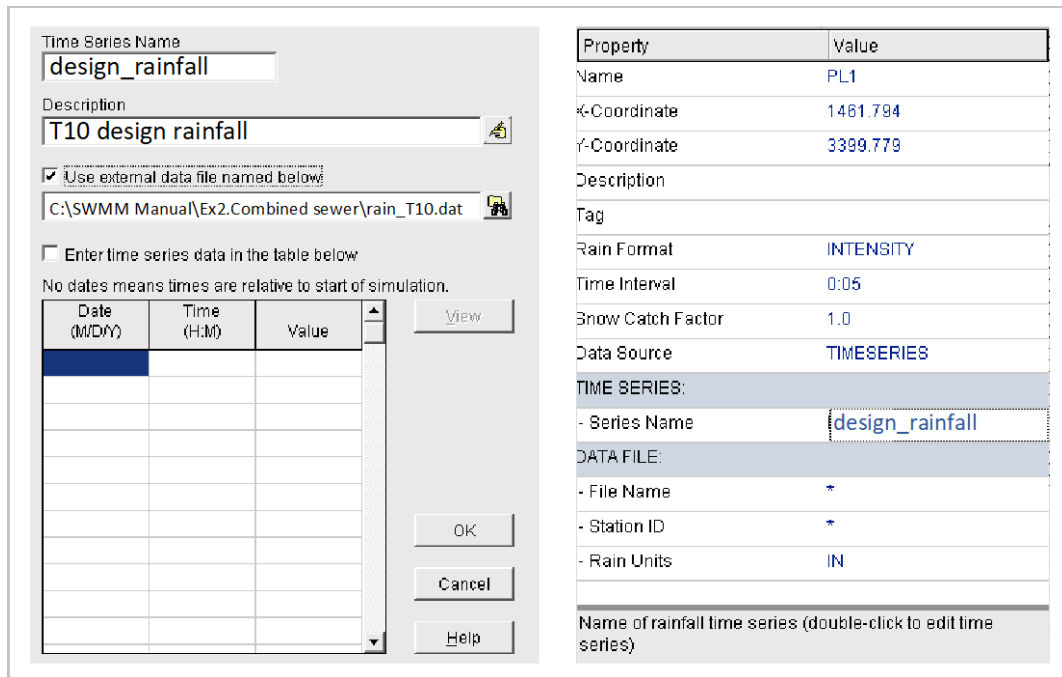

Figure 25. Definition of the rainfall data in the combined sewer network model.

4.2.4 Analysis and simulation options

The analysis options must be defined before running the model. To do this, select *Options* in the *Project* side navigation panel. On the *General* tab no changes are necessary if the default options have been entered correctly in section 4.2.1. In the *Dates* tab, a 4 hours simulation length must be defined. As we have not defined the date (in MM/DD/YY format) in the precipitation time series, we do not need to change these parameters. In the *Time Steps* tab the time interval for results reporting must be established, typically in the range from 1 to 5 minutes (Figure 26). Next, the time step intervals for dry weather flow, wet weather flow and flow routing must be set. Typical values are 15-30 minutes for dry weather, 1-5 minutes for wet weather, and 5-30 seconds for pipe flow routing. The values in the *Dynamic Wave* tab will be set as shown in Figure 26.

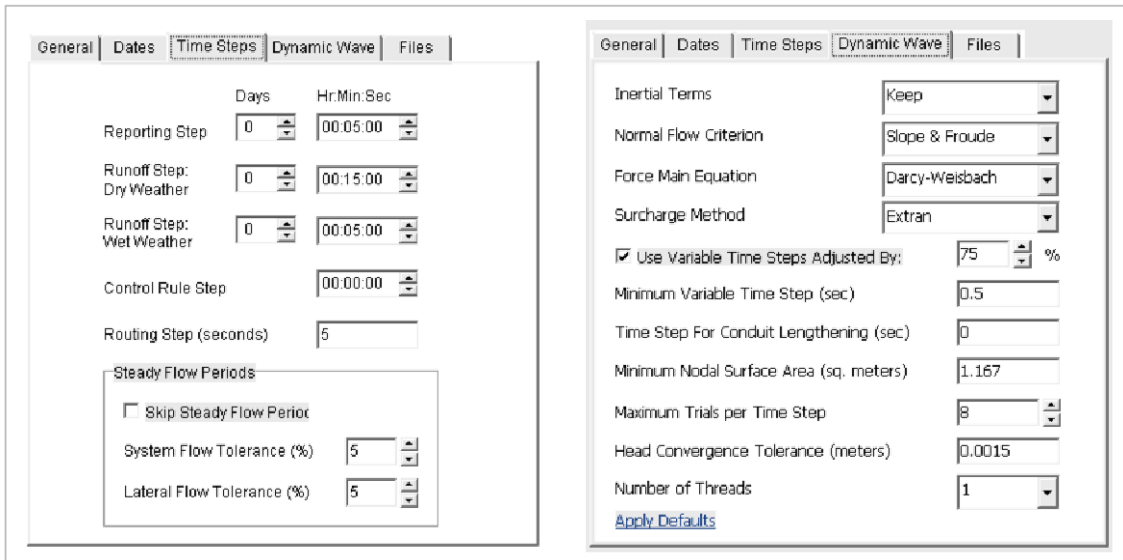



Figure 26. Simulation options in the combined sewer network model.

The simulation is then performed by clicking on the icon  or by selecting *Project >> Run Simulation* from the main menu. Immediately after the simulation, a window will inform us that the model has run without any setback and that the continuity errors are small. If something is going wrong in the simulation, the model and the error codes shown in the *Status report* must be checked to fix the model.

4.3 Model results

Once the simulation is performed, we can review the *Status Report* (*Report >> Status* menu) and the *Summary Report* (*Report >> Summary* menu). The *Status Report* would not report any problems since there are no significant continuity errors. The *Summary Report* allows to analyse the general hydraulic performance of the drainage system by displaying different summaries of all the elements of the model grouped by its type.

Figure 27 shows the *Summary Report* outputs for pipes (*links*) and manholes (*nodes*) with flooding. The report provides information on the recorded worst-case values and the exact time of occurrence. This is very important because it allows the detection of problems not shown in the results. As an example, the instant of maximum flow in the P.4 pipeline occurs at the 43rd minute of simulation and would not be shown in the general results as these are shown in 5-minute intervals (as indicated in the simulation options).

In Figure 27 it can also be seen that the P.1 pipe has a maximum ratio $y/D=1$, which means that the pipe is surcharged and potentially, a flood event could be recorded. To check if flooding occurs, the list of items in the *Summary Report* is called *Node Flooding*. If this item appears in the list, then flooding occurs.

In nodes N.1 and N.2, floods of 0.08 hours (5 minutes) and 0.03 (2 minutes) are recorded, respectively (Figure 27). Figure 28 shows the longitudinal profile (*Graph >> Profile Plot*) between nodes N.1 and O.1 at reporting time 00:45. The plot displays how the water surface reaches the urban ground in node N.1.

An introduction to sewer network design using SWMM

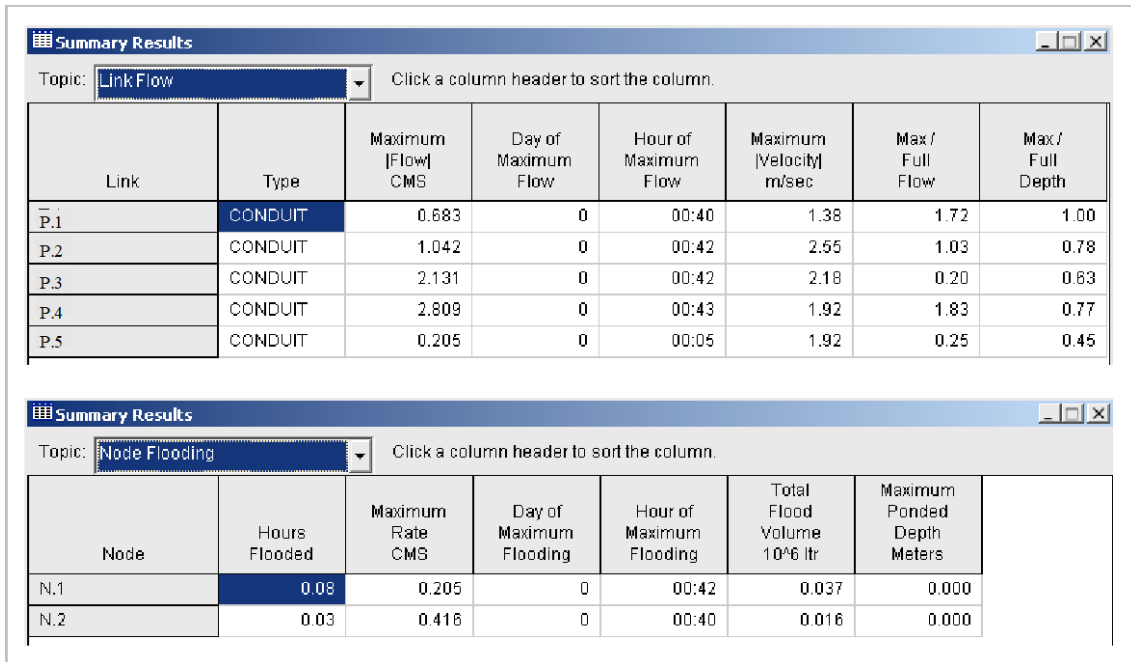

Figure 27. Link Flow tab and Node Flooding tab in the Summary Report of the combined sewer network model.

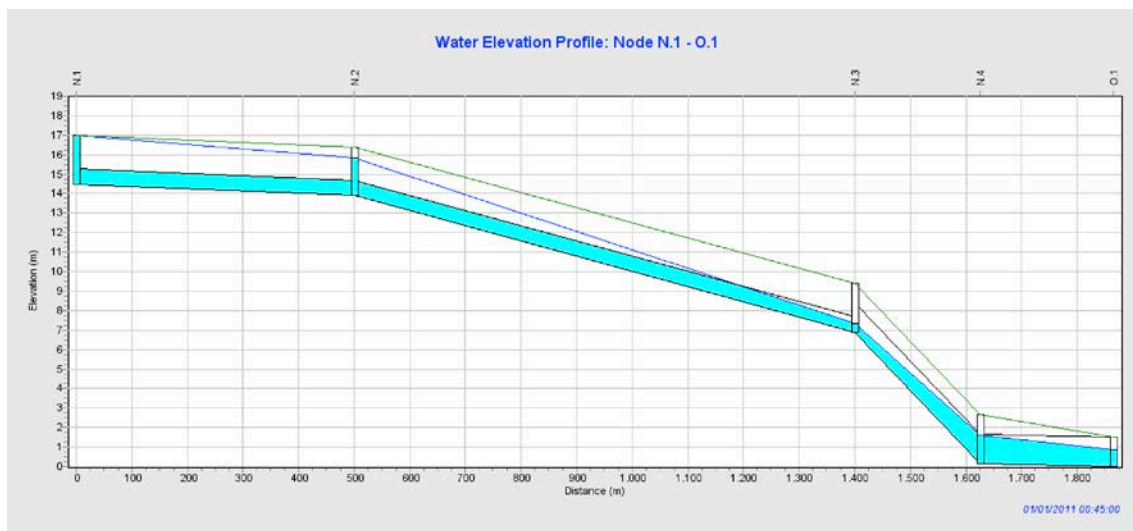

Figure 28. Longitudinal profile between nodes N.1 and O.1 of the combined sewer network model at 00:45.

The network should increase its drainage capacity to solve flooding problems. In most cases, this can be achieved with one of the following strategies: (i) increasing the wetted area of the pipe, (ii) increasing the slope, (iii) using materials with a lower roughness coefficient, or (iv) reducing minor (punctual) head-losses.

In the proposed example, P.1 and P.2 pipe diameters will be increased. Such changes should always be performed from downstream to upstream, because in some cases an upstream surcharged pipe could be fixed just by changing the drainage capacity of one or more downstream pipes.

An introduction to sewer network design using SWMM

The properties of the P.1 and P.2 pipes are edited and their diameter changed from 800 mm to 1000 mm. Running the model again and reviewing the *Summary Report* or the network longitudinal profile (*Graph >> Profile Plot*) shown in Figure 29, it is verified that surface flooding no longer occurs.

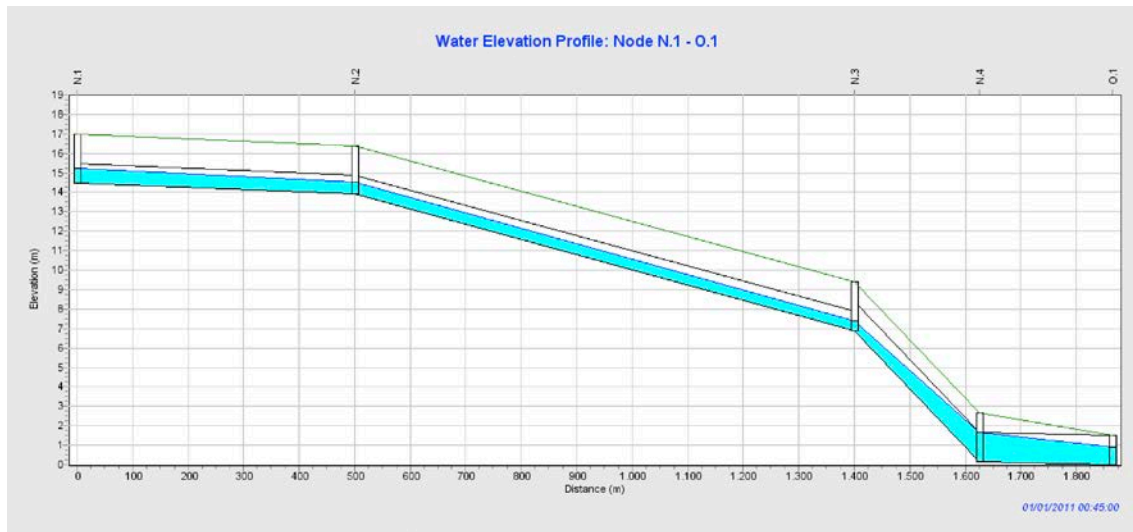

Figure 29. Longitudinal profile between nodes N.1 and O.1 of the combined sewer network model after increasing P.1 and P.2 pipe diameter to 1000 mm.

In addition to ensuring that there is no flooding, it should be checked that the filling ratio of the pipes, y/D , is less than 0.75. This condition is linked to the design return period, as established by the UNE-EN-752 drainage standard and reported in the ITOHG SAN 1/0. Sewage Systems (Aguas de Galicia, 2010). The *Summary Report* shows that the maximum ratio is only slightly exceeded in P.4 pipe, reaching a value of 0.79 (Figure 30). Given the didactic nature of the example, this value is considered acceptable and no further changes are performed to the drainage network. The *Summary Report* also shows that the maximum flow velocity does not exceed 3 m/s, which is the reference value for concrete pipes.

Summary Results							
Topic: Link Flow		Click a column header to sort the column.					
Link	Type	Maximum (Flow) CMS	Day of Maximum Flow	Hour of Maximum Flow	Maximum (Velocity) m/sec	Max / Full Flow	Max / Full Depth
P.1	CONDUIT	0.612	0	00:42	1.09	0.85	0.67
P.2	CONDUIT	1.181	0	00:43	2.72	0.64	0.54
P.3	CONDUIT	2.227	0	00:43	2.15	0.21	0.65
P.4	CONDUIT	2.908	0	00:44	1.94	1.90	0.79
P.5	CONDUIT	0.205	0	00:05	1.93	0.25	0.46

Figure 30. Link flow summary report tab in the combined sewer network model once the diameter of P.1 and P.2 pipes has been increased.

Figure 31 shows the flow hydrograph for all the pipes of the drainage network, after increasing pipes P.1 and P.2 diameter. It can be observed that in pipe P.5 the flow is constant and equal to 0.2 m³/s, which corresponds to the dry weather flow rate introduced in node N.5. The maximum flow rate is about 2.9 m³/s.

An introduction to sewer network design using SWMM

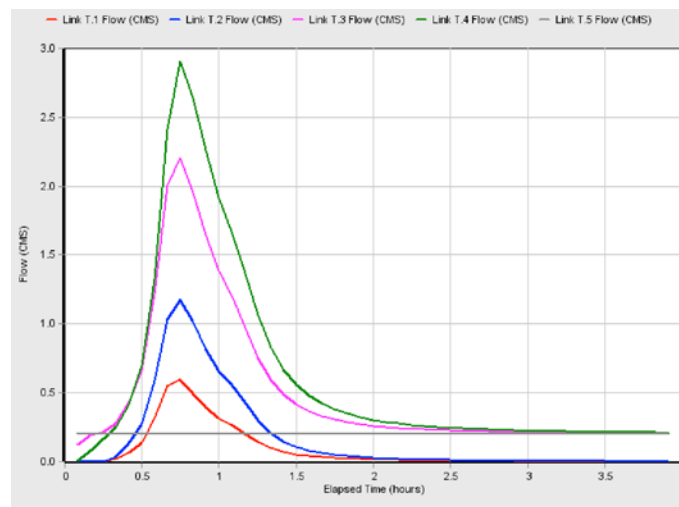

Figure 31. Flow hydrograph in all the pipes of the combined sewer network model, once the diameter of P.1 and P.2 pipes has been increased.

5 CSO STORMWATER TANK DESIGN

5.1 Problem statement

This chapter starts from the combined sewer network modelled in Chapter 4 and introduces the preliminary sizing of a CSO stormwater tank at the drainage network outlet. To do this, the simplified method proposed in the ITOHG (Aguas de Galicia, 2010) for an urban area spilling the CSO to a non-sensitive area. Initially, the stormwater tank is sized using the T=10 years return period design rainfall. The adequate behaviour of the drainage network and CSO tank spillways is checked against flooding using this rainfall pattern.

Based on the model described in Chapter 4, the following changes have to be made:

- To define head-losses at pipe inlet and outlets, using minor loss coefficient values of 0.2 and 0.5 respectively.
- To change the dry weather flow rate introduced in node N.4 (200 L/s) to the design wastewater flow for combined sewer systems according to the recommendations for Galicia region (Aguas de Galicia, 2010). This flow rate corresponds to the total peak hourly flow rate, $QH_{p,total}$, which is estimated from a wastewater allocation of 1.5 L/s/ha.
- To limit the throttle discharge to the WWTP by using an ideal flow regulator that allows a maximum flow of three times the total daily peak flow, $3 \cdot QD_{p,total}$. This flow rate is calculated using wastewater allocation of 0.6 L/s/ha.
- To introduce an overfall sharp-crested spillway at a 2 m height and a discharge coefficient ($C_D=1.7$) appropriate for T=10 years design rainfall. The maximum height of the tank is set at 3 m.
- To introduce two outfalls in the tank, representing the throttle flow conducted to the WWTP and the CSO overflow conducted to aquatic media. Both outfalls will be modelled using critical depth boundary conditions.

Once the design rainfall criterion has been checked, the operation of the tank is analysed in terms of CSO flow control following the methodology proposed at ITOHG SAN 1/5 (Aguas de Galicia, 2010). For this purpose, the annual rainfall time-series corresponding to the yearly “average” rainfall profile is used.

5.2 CSO stormwater tank sizing using the design rainfall

To set the head-losses at the inlet and outlet of the pipes, loss coefficients 0.2 and 0.5 must be entered, respectively. These values can be modified one by one in all the pipes of the model, or by using the *Select Region*  tool to change all the objects simultaneously. The whole catchment will be selected with the *Select Region* tool and the *Group Editor* option in the *View* menu is used to change all the head-losses at the inlet and outlet of the conduits as shown in Figure 32.

An introduction to sewer network design using SWMM

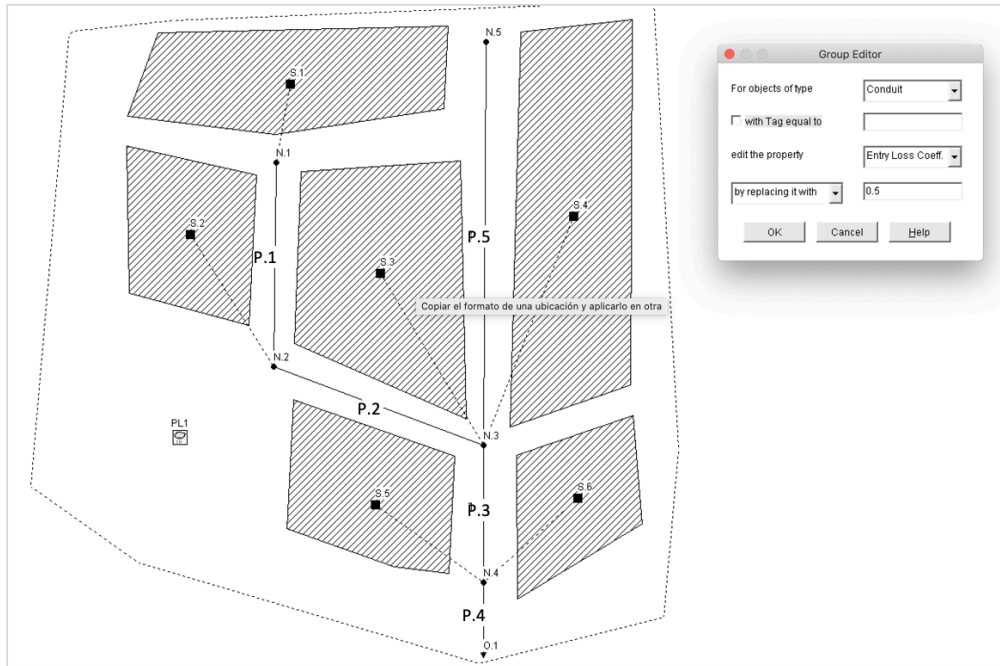

Figure 32. Edition of the model object properties using the Group Editor option.

The dry weather design flow rate is considered to be equal to the total hourly peak flow rate, $QH_{p,total}$. The $QH_{p,total}$ allocation is estimated at 1.5 L/s/ha. The catchment area can be calculated from the data included in the *.inp* input file, which can be read with a text editor, or from the *Project >> Details* menu. In the *[SUBCATHMENTS]* tab, the total area of each subcatchment and the imperviousness coefficient are shown (Figure 33). The total area of the model is 50 ha and the impervious area, calculated from the product of the area of each subcatchment and its imperviousness percentage, is 30.1 ha. The $QH_{p,total}$, estimated as the product of the total surface and 1.5 L/s/ha, is equal to 75 L/s. This flow rate is introduced as dry weather wastewater flow in node N.4.

Data Category	Name	Rain Gage	Outlet	Area	%Imperv	Width	%Slope	CurbLen	SnowPack
[TITLE]	S.1	PL1	N.1	10	60	500	2	0	
[OPTIONS]	S.2	PL1	N.2	8	75	900	6	0	
[EVAPORATION]	S.3	PL1	n.3	9	80	225	4	0	
[RAINGAGES]	S.4	PL1	n.3	12	20	240	5	0	
[SUBCATHMENTS]	S.5	PL1	n.4	6	75	200	1	0	
[SUBAREAS]	S.6	PL1	n.4	5	80	200	3	0	

Figure 33. Subcatchment properties in the CSO stormwater model.

The stormwater tank is calculated using Table 1 of the simplified method of the ITOHG SAN 1/5 (Augas de Galicia), which proposes a specific storage volume of 80 m³/ha net or impermeable. Therefore, the total volume of the tank up to the spillway height will be 2408 m³. If the height of the spillway is set at 2 m, the total surface of the tank will be 1204 m².

The maximum throttle flow rate to the WWTP is equal to $3 \cdot QD_{p,total}$. The total daily peak flow, estimated using a 0.6 L/s/ha allocation, is equal to $QD_{p,total} = 30$ L/s. Thus, the maximum throttle flow rate is set at 90 L/s.

The overflow spill CSO discharge depends on the tank geometry (due to the storage flow attenuation) and the length of the spillway. To size the length of the spillway, the maximum flow rate determined with the model is used. The model of the drainage network has to be run after changing the dry weather flow rate and adjusting the minor head-losses (without tank). The maximum flow rate in the outlet pipe is 2.8 m³/s, which is considered as the spillway design flow discharge. The length of the overfall is calculated using the discharge equation for transverse spillways:

$$Q = C_D \cdot L \cdot H^{1.5}$$

where C_D is the discharge coefficient equals to $C_D=1.7$, H is the water elevation above the spillway fixed at 0.20 m, Q is the spillway flow discharge equals to 2.8 m³/s. The spillway length can be estimated thus as $L = 20$ m.

The next step is to define the CSO tank and the outfall nodes in the drainage network model. By right-clicking in the outfall O.1, we can convert this node into a *Storage unit* that represent the CSO tank. Then, we proceed to rename this element as TANK in the object properties. Two new outfall points are added using *Outfall* ▾ type elements to define the WWTP throttle flow regulator and the CSO spill. These nodes will be renamed as WWTP and CSO. Finally, we connect the TANK node with the CSO outfall using a *Weir* 🏰 type element, that we will rename as Spillway, and with the WWTP outfall using an *Outlet* 🏠. The outlet link will act as the throttle flow regulator. Figure 34 shows the final arrangement of the elements in the model.

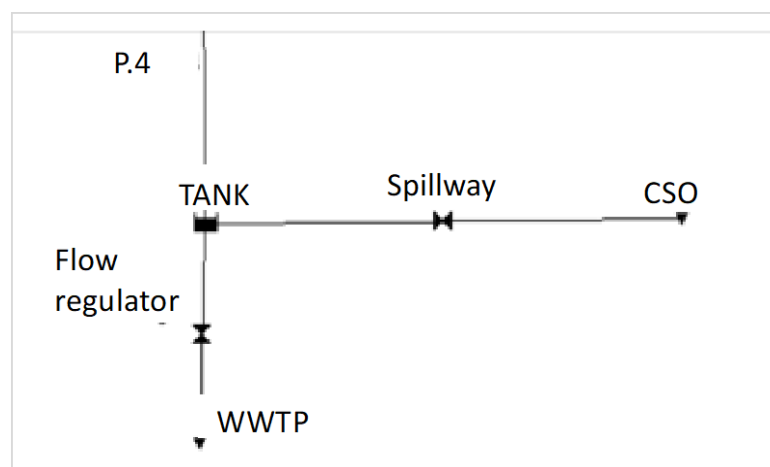

Figure 34. Layout of the CSO tank connections with the CSO spill point and the WWTP throttle flow regulator.

CSO tank properties must be edited. The tank will be located at +0 m elevation, which will be entered in the *Invert El* property. The total height of the tank must exceed the level of the spillway crest to avoid numerical instability problems. In this example, the total height of the tank has been defined as 3 m. This value is entered in the property *Max. Depth*.

To define the geometry of the tank, a new *Curve >> Storage Curves* in the navigation panel will be introduced. The storage curve is defined using a water depth vs tank surface relationship. A prismatic tank with a constant area of 1204 m² is considered. Two points are sufficient to define the rating curve: (0,1204) and (3,1204). The abscissa

corresponds to the minimum and maximum tank elevation and the ordinate corresponds with tank surface. The input data to define the rating curve and SWMM curve plots are shown in Figure 35. Once the rating curve is defined, it must be assigned to the stormwater tank in the Storage Curve option of the TANK element properties by selecting the Tabular type (see Figure 36).

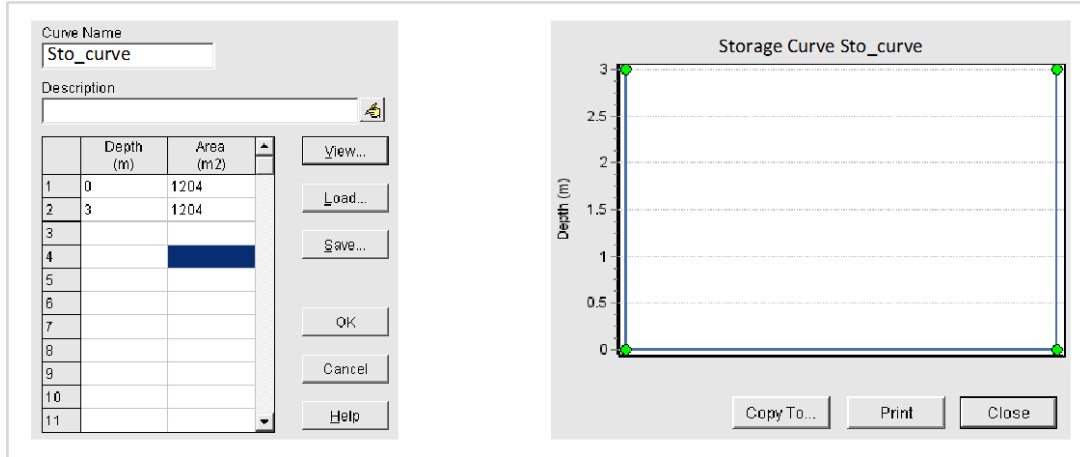

Figure 35. Definition of tank rating curve CSO stormwater tank model.



Figure 36. Storage unit properties.

To define the tank throttle flow to WTPP, an ideal flow regulator with a maximum flow discharge of 90 L/s is used. A flow curve is defined with the option *Curve >> Rating Curve* on the navigation panel. The flow regulator curve will consist of 3 pairs of points as shown in Figure 37. The first point is (0, 0) meaning that, if the tank is empty, the output flow is zero. The second point (0.3, 0.090) serves as a transition zone between zero flow and maximum flow. In this way, we avoid sudden emptying of the tank that would generate numerical instabilities and continuity errors. Finally, point (3, 0.090) is set for ensuring that the maximum flow rate is equal to $3-QD_{p,total}$ for the remaining tank water depths. The rating curve must be assigned to the *Flow regulator* outlet by editing its properties: defining *Rating Curve* equal to *Tabular/Depth* and selecting the curve name in *Tabular Curve*, as shown in Figure 38.

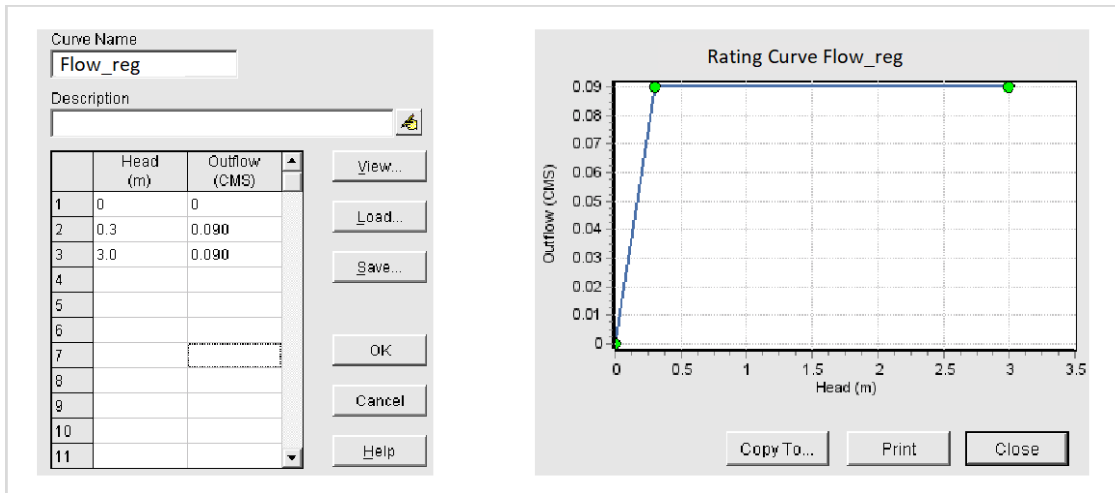

Figure 37. Stormwater tank rating curve.

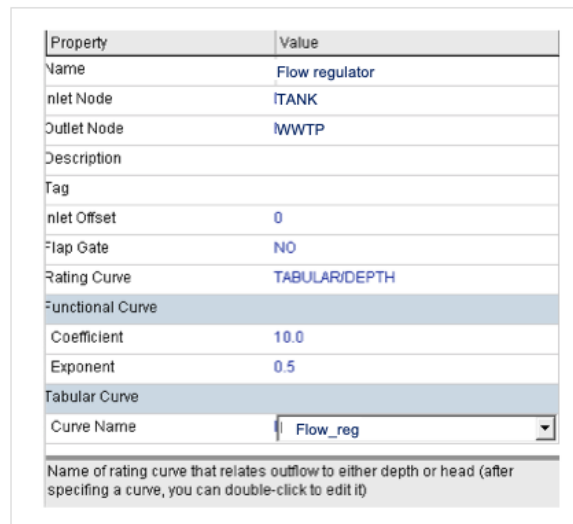



Figure 38. Flow regulator properties

The properties of the *Spillway* element are also edited: the length of the crest (*Length*), the opening (*Height*) and the crest height (*Weir Offset*). The length of the spillway is 20 m, its height is 1 m (this is the distance between the crest and the tank top) and the height of the spillway crest is 2 m. *Transverse* is set as spillway *Type* with a discharge coefficient (*Discharge Coeff*) equal to 1.7. The properties of the spillway are shown in Figure 39.

Property	Value
Name	Spillway
Inlet Node	TANK
Outlet Node	CSO
Description	
Tag	
Type	TRANSVERSE
Height	1
Length	20
Side Slope	0
Inlet Offset	2
Discharge Coeff.	1.7
Trap Gate	NO
End Contractions	0
End Coeff.	0
Can Surge	YES
Coeff. Curve	

Optional name of curve that relates discharge coefficient to head (double-click to edit the curve)

Figure 39. Spillway properties

After modifying the network model, the simulation is executed by clicking on the icon  or by selecting *Project >> Run Simulation* from the main menu. Immediately after the simulation, a window will appear indicating to the user that model has run correctly and that the continuity errors are reduced. If any error occurs in the simulation, the error codes indicated in the *Status Report* must be checked to solve them.

Then, we can follow the procedure of the previous problems to check simulation results. The *Status report (Report >> Status)* is checked for error messages or continuity problems and the *Summary report (Report >> Summary)* for surface flooding. No issues should appear; if they do, the model definition should be reviewed.

Network and tank operation are checked in the *Summary Report* on the *Link Flow* tab, which will show maximum flows, maximum velocities and pipe filling rates. Flow velocities are adequate in all pipes. The P.4 pipe - inlet to the tank – is surcharged due to the boundary condition imposed by the tank when is fully filled with water (see Figure 40). This situation is common in the areas upstream of the CSO tanks, and there is no need to worry as long as no flooding occurs.

An introduction to sewer network design using SWMM

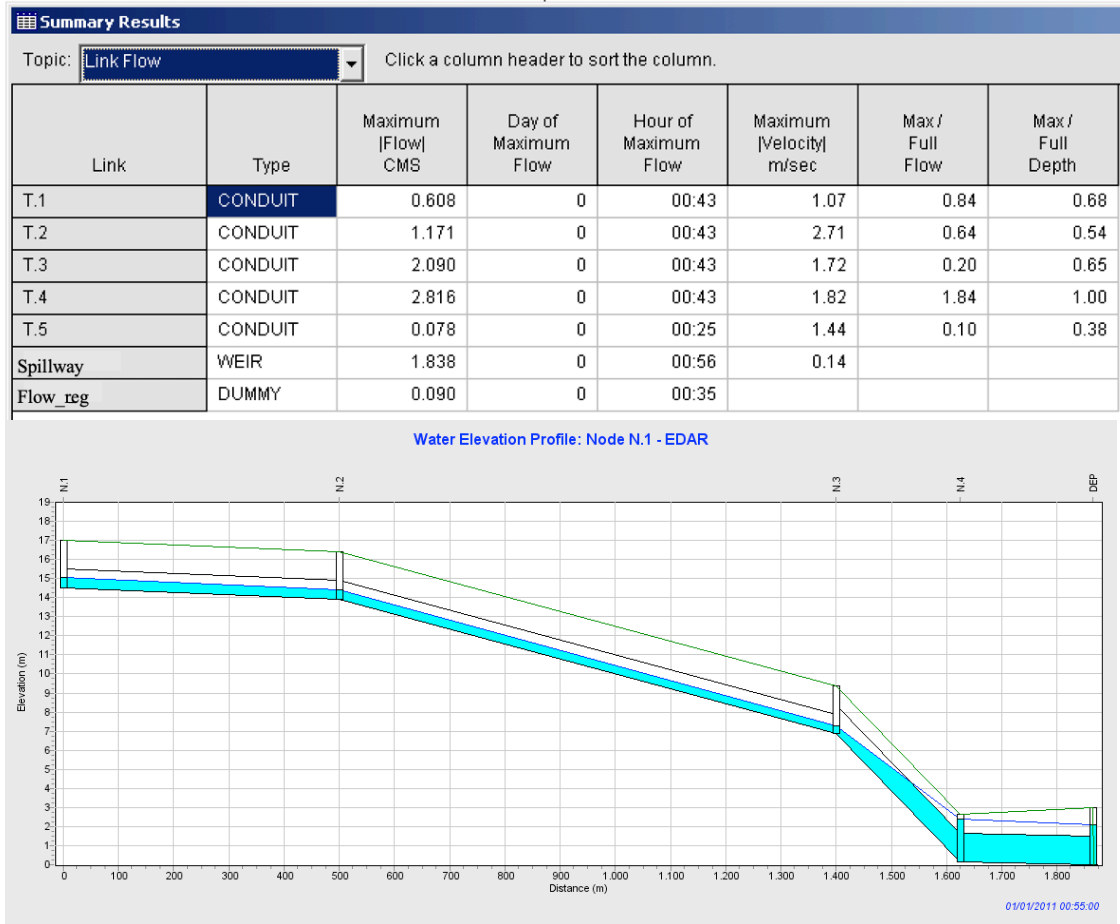

Figure 40. CSO stormwater model results with the design rainfall: pipe flow summary and longitudinal profile between the N.1 manhole and WWTP outfall.

In order to analyse flooding, manhole and CSO tank water depth safeguard may be checked in the *Node Depth* tab of the *Summary Report* (Figure 41). The lowest safeguard is 21 cm in node N.4 (the maximum water depth is 2.29 m and the total manhole height is 2.50 m). The water surface in the tank reaches a height of 2.14 m, so the maximum level above the spillway crest is 14 cm.

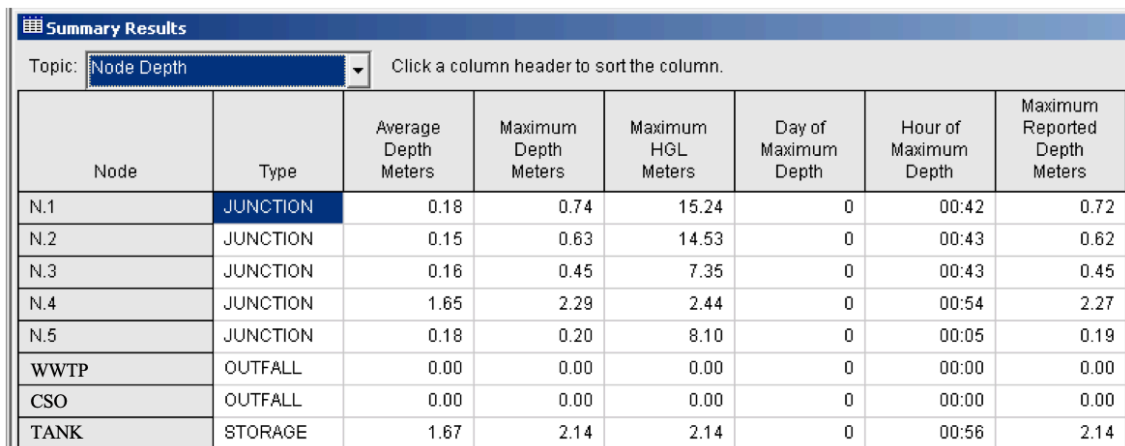

Figure 41. CSO stormwater model results with the design rainfall: maximum node depth

Finally, the behaviour of the stormwater tank with the design rainfall of T=10 years is evaluated. Figure 42 shows the tank inlet, outlet and CSO flow discharge illustrating the operation of the tank and its effect on the drainage network. To plot this figure, the option *Report >> Graph >> Time Series* has been used. The inflow hydrograph (red line) has a maximum flow rate of 2.82 m³/s at the 43rd minute of the simulation (see also Figure 40). The CSO discharge hydrograph (magenta line) reaches a maximum of 1.84 m³/s at the 56th minute of the simulation. The differences between the maximum flows and the time of the peak flow are due to the storage flow attenuation at the tank. The WWTP throttle discharge (blue line) is bounded by a maximum flow rate of 90 L/s (corresponding with 3-QD_{p,total}). The figure also shows how tank emptying extends beyond the maximum simulation time.

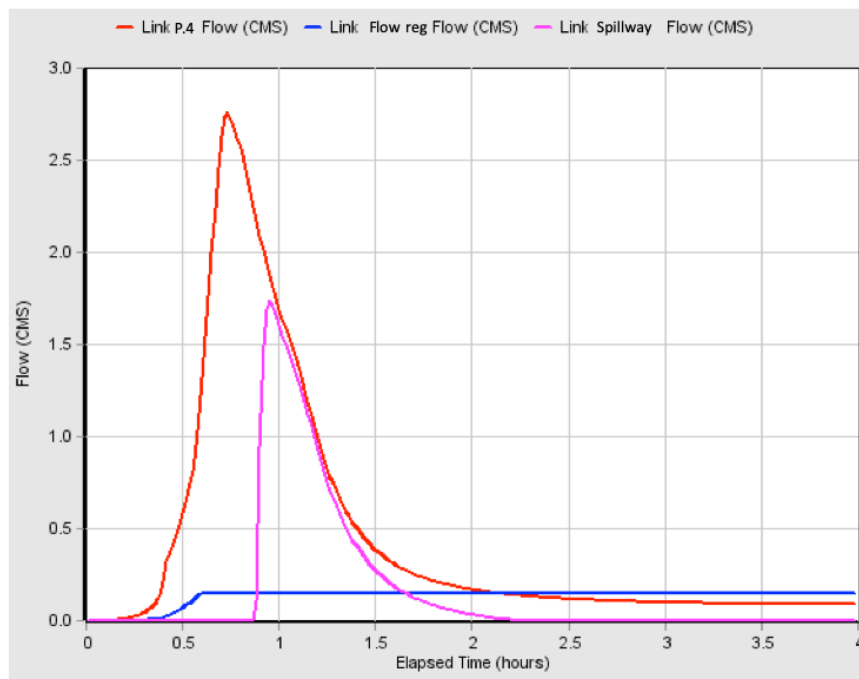

Figure 42. CSO stormwater model results with the design rainfall: tank inlet, outlet and CSO discharge.

5.3 CSO stormwater tank sizing using the average year rainfall record

The evaluation of drainage network using the design rainfall aims to prevent flooding. In this section, the system will be evaluated for an average year of rainfall.

The model developed in the previous section will be used as starting point, by saving the file using a different name. To perform the continuous model analysis, the dry weather flow allocations and the rain record must be modified in the model, and also an evapotranspiration value must be introduced in the model.

The dry weather wastewater flow rate, which is entered in node N.5, should be fixed as the total daily peak flow rate (QD_{p,total}). We must edit the *Inflows* property in N.5 node *Properties* window and include an average flow rate of 30 L/s on the *Dry Weather* tab (Figure 43).

An introduction to sewer network design using SWMM

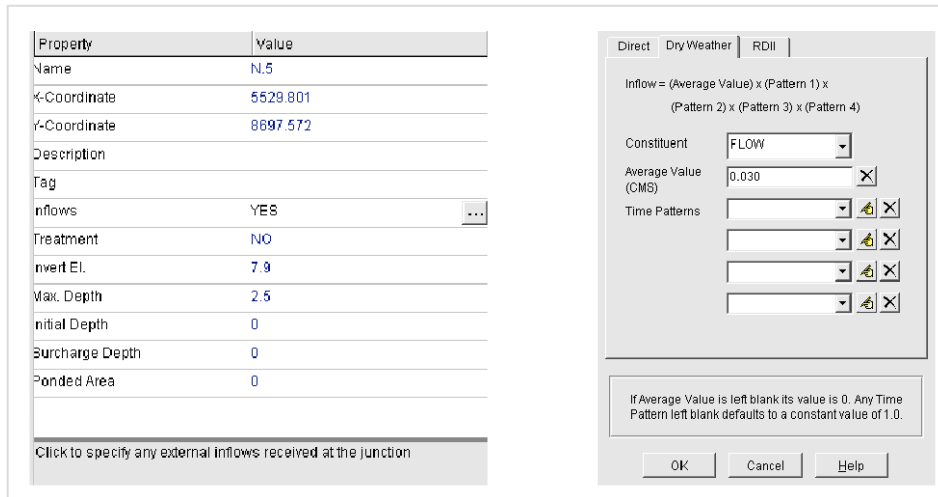

Figure 43. Definition of $QD_{p,total}$ in node N.5 for the continuous model simulation.

The next step consists of preparing a rainfall data file with the average year rainfall record to be modelled. The characteristics of the average year are indicated in the ITOHG SAN 1/5 regulation (Augas de Galicia, 2010). In the provided supporting electronic files, two files containing the average rainfall record are delivered in .xls and .dat formats, in addition to the model files (see chapter 6). The .xls file contains the time series of the representative raingage in the average year, which in this case is the year 2008. The .dat file is the input file format that must be selected to run the model in SWMM.

To build the input file for the model, the time series records with zero rain volume must be removed. A plain text file must be created with the following structure:

Station ID	Year	Month	Day	HH	MM	P
R01	2008	1	1	9	30	1.2

The *Station ID* parameter is the name of the raingage. Then, the time stamp of each rain record is provided by entering in each column the value of the year, month, day, hour, and minute. The recording interval must be constant, and the rainfall record must have a maximum of ten-minute temporal resolution. In the last column, the rainfall is added in volume format, millimetres of accumulated rain for each time interval (mm), or in rain intensity format (mm/h). Usually, long-term rainfall records are expressed in rainfall volume format (mm or L/m²). In the rainfall input file (average_year_18.dat), rainfall is in volume format (mm), has a time resolution of 10 minutes and the raingage is called R01.

The precipitation is configured in the PL1 raingage properties where the following options must be modified (Figure 44):

- *Rain Format: VOLUME.*
- *Time interval: 10 minutes.*
- *Data Source: FILE.*
- *DATA FILE/File Name: File path.*
- *Raingage name (DATA FILE/Station ID): R01.*
- *Rain Units (DATA FILE/Rain Units): mm.*

An introduction to sewer network design using SWMM

Property	Value
Name	PL1
X-Coordinate	1461.794
Y-Coordinate	3399.779
Description	
Tag	
Rain Format	VOLUME
Time Interval	0:10
Snow Catch Factor	1.0
Data Source	FILE
TIME SERIES:	
- Series Name	lluvia_diseño
DATA FILE:	
- File Name	C:\Manual SWMM\Ejemplo 3.Tanque antiDS\Utaño_medio_18.dat
- Station ID	R01
- Rain Units	MM
Units of rainfall data	

Figure 44. Raingauge properties in the continuous simulation model.

Furthermore, we have to modify the simulation starting and ending analysis dates from 01/01/2008 - 00:00 to 01/01/2009 - 00:00 at the *Options >> Dates* window (Figure 45).

	Date (M/D/Y)	Time (H:M)
Start Analysis on	01/01/2008	00:00
Start Reporting on	01/01/2008	00:00
End Analysis on	01/01/2009	00:00
Start Sweeping on	01/01	
End Sweeping on	12/31	
Antecedent Dry Days	0	

Figure 45. Edition of starting and end analysis date.

To finish model update, a daily evapotranspiration mean value must be introduced to allow surface shallow depression volume to evaporate after rainy events. In the navigation panel we will introduce in the *Evaporation* tab of the *Climatology* option an evaporation value of 1.5 mm/day (Figure 46).

An introduction to sewer network design using SWMM

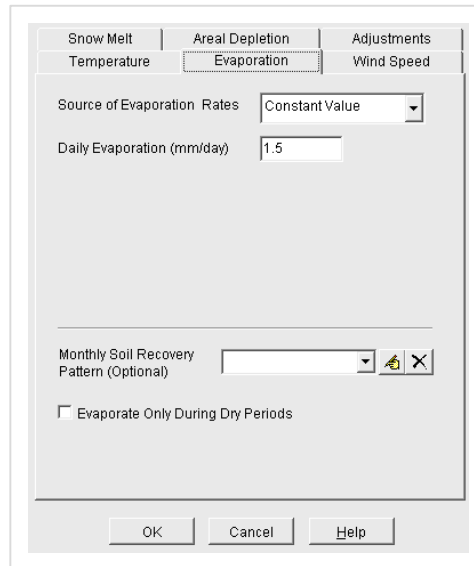

Figure 46. Edition of evapotranspiration properties in continuous model.

Then, the model can be executed again by clicking on the icon . The model run may take a couple of minutes to finish the simulation. Afterwards, a window indicates that the execution has been successful with small continuity errors. If any error occurs in the simulation, the error codes shown in the status report must be checked to solve them.

In the *Status report* (*Report >> Status*) error messages or continuity problems can be consulted. Meanwhile, flooding episodes can be found in the *Summary report* (*Report >> Summary*). If any incidence is detected, model must be checked.

The analysis of the average year will focus on determining both CSO spill volume and frequency. ITOHG regional regulations (Aguas de Galicia, 2010) proposes the following Emission Standards to assess CSO tank performance:

- CSO spill frequency ranging between 15-20 spill per year.
- CSO annual volume is limited to a maximum value of 15%-20% of the total annual runoff volume. This is equivalent to fix a throttle runoff flow volume to WWTP ranging from 85% to 90% of the total annual volume.

To check compliance with ITOHG ES in SWMM, two different tools will be used. To determine the percentage of annual runoff volume spill by the CSO tank, the *Outfall Loadings* tab of the *Report Summary* will be considered (Figure 47). The summary table shows the total volume of water discharged in the simulation through the throttle flow regulator *outfall* to the WWTP and to the aquatic media through the CSO *outfall*.

Summary Results				
Topic: Outfall Loading		Click a column header to sort the column.		
Outfall Node	Flow Freq. Pcnt.	Avg. Flow CMS	Max. Flow CMS	Total Volume 10 ⁶ ltr
WWTP	100.00	0.037	0.090	1171.940
CSO	0.48	0.108	0.519	16.368

Figure 47. CSO stormwater model results with the annual rainfall record: outfall volumes summary.

The following methodology can be used to determine the percentage of runoff discharged by the CSO, also called tank performance or efficiency in terms of runoff volume:

1. The total annual wastewater volume during dry and weather periods can be estimated as the sum of the throttle flow volume conducted to the WWTP and the CSO spill volume: 1,188,308 m³/year.
2. Dry weather wastewater flow volume is equal to 30 L/s, which accounts 946,080 m³/year.
3. Urban runoff volume is determined by subtracting the previous two values. Therefore, the annual runoff volume is 242,228 m³/year.
4. Tank volumetric performance is the ratio of CSO spill volume (16,368 m³/year) and the total stormwater runoff volume (242,228 m³/year). Stormwater tank spill efficiency is 6.75%, which is below the limit established in the ITOHG.

SWMM statistical analysis tool will be used to evaluate CSO spill frequency, which can be accessed by pressing Σ button on the toolbar. This tool allows to perform statistical analysis on all the elements of the network and also in the whole drainage system. A couple of examples are presented in Figure 48 and Figure 49 to show the capabilities of this tool, including the determination of CSO spill frequency.

Figure 48 shows the input data window to perform a statistical report, as well as the summary of parameters obtained when analysing the rain events recorded in the annual rainfall record. The statistical report window allows selecting the type of object to be analysed and the variable to be analysed. In this case, as the rainfall is referred to the whole model, the *System* option is chosen as *Object Category*. The variable to be analysed is the precipitation (*Variable Analyzed >> Precipitation*), although other variables could be selected such as direct runoff, infiltration, etc. Then, time period is defined to be analysed. In the *Event Time Period* variable, you can choose to analyse isolated rain events (*Event-Dependent*) or perform daily, monthly or annual statistical analyses. The last variable in the reports is the type of statistic to be analysed. For example, the average intensity, the maximum intensity, or the total volume of each rainfall event can be determined. The latter is the option selected in Figure 48 (*Statistic >> Total*).

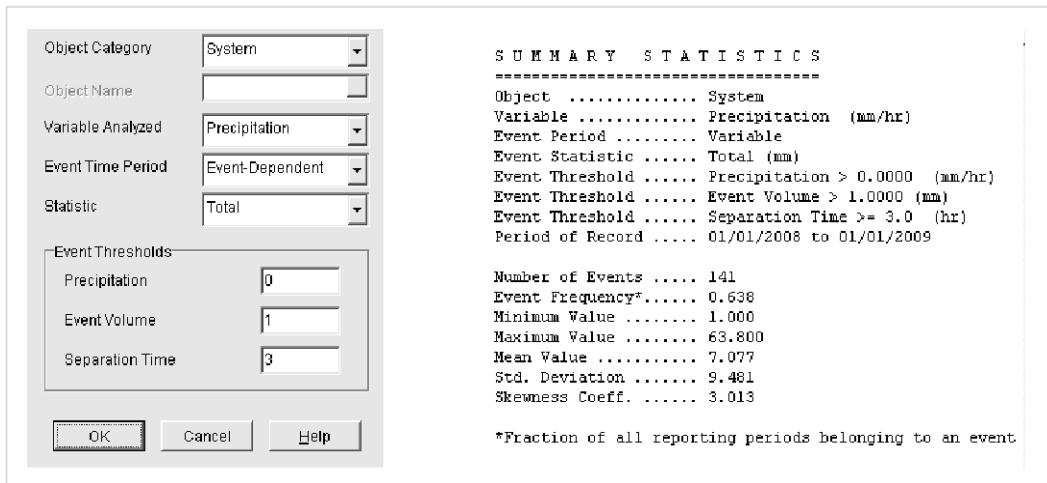



Figure 48. CSO stormwater model results with the annual rainfall record: rainfall event analysis.

When analysing single events, some thresholds values has to be fixed to determine when two consecutive rains are considered as a single event and when they are accounted as two different events. For instance, if it starts raining for 2 hours, then stops for a period of 15 minutes, and then rains again for 3 hours, how do we consider this rain sequence? Are we talking about two rain events or one single event with a short break in the middle? The answer to this question is not trivial. There are several ways, more or less sophisticated, to decide whether in the above example we are talking about one or two rain events. If we wish to go deeper into the problem of the adequate definition of the separation time between rain events, also called inter-event time, chapter 4 of Adams and Pappa (2000) book can be consulted. In Spain it is recommended to use an inter-event time of roughly 3 hours. Thus, *Separation Time* variable, in *Event Thresholds*, is fixed in 3 hours in Figure 48.

Precipitation and *Event Volume* options allow defining other thresholds to rule out, for example, small rain events with very little intensity or volume. For instance, it is common to exclude rain events of less than 1 mm in volume because, due to depression storage, evaporation and eventual infiltration losses, they will not produce surface runoff. In this example, *Event Volume* is defined as 1 mm (Figure 48).

SWMM provides us as a report of the statistic analysed. In this example, 141 rain episodes are recorded during the average year. The average rainfall volume of each event is 7 mm, although the maximum record is 63.8 mm.

After showing the capabilities of SWMM statistical tool, we will move on determining CSO frequency. Before clicking statistical tool button , it is recommended to select the object to be studied. In this case, click on the *Spillway* link. Thus, when opening the tool with the button, this element is already selected for analysis. The variable to be analysed is the flow rate (*Variable Analyzed* >> *Flow*), using an *Event-dependent* analysis with *Total* flow statistic, which corresponds to the spill volume (Figure 49). The thresholds values to define single CSO events are: minimum discharge volume of 50 m³ (*Event Volume* >> 50) and event separation time of 3 hours (*Separation Time* >> 3).

CSO spill frequency statistical report is presented on the right side of Figure 49. It can be observed that the total number of spills is 11 during the average year. This value is also smaller than the limit established by the ITOHG by 15-20 discharges.

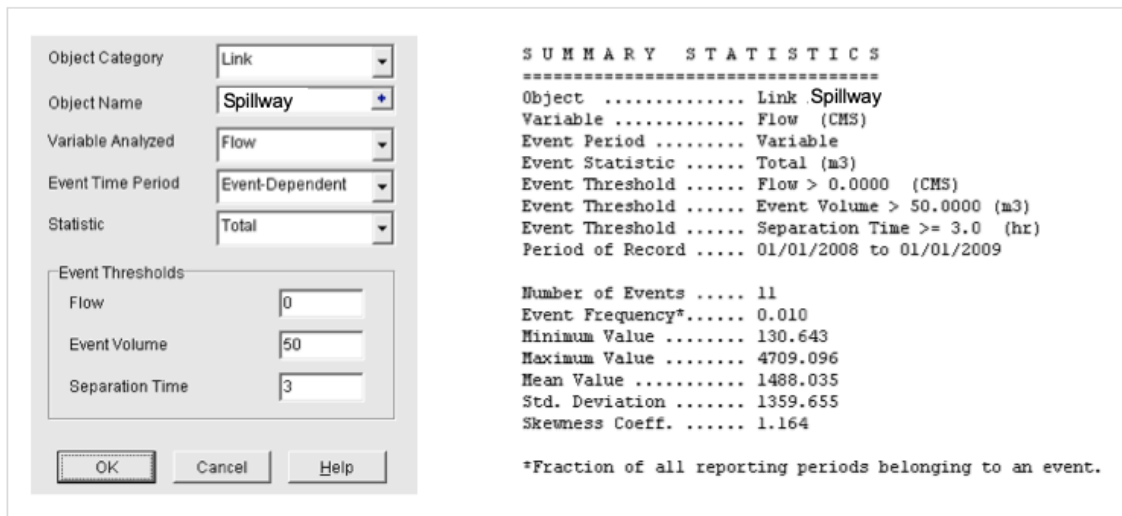

Figure 49. CSO stormwater model results with the annual rainfall record: CSO spill frequency.

Therefore, the proposed stormwater tank added easily fulfil ITOHG standards in terms of CSO spill frequency and CSO volume. For this reason, CSO tank design could be optimized by slightly reducing its storage volume, either by reducing the tank surface area or tank height. Usually, we will proceed by reducing tank surface, because crest elevation is commonly constrained by drainage and discharge point ground levels. The optimization of the tank volume by changing the surface in the tank storage curve, remains as a working proposal for the students of this manual.

6 DATA PROVIDED TO DEVELOP THE EXAMPLES

The compressed zip file with the permanent URL <https://doi.org/10.17979/spudc.9788497497909> contains the examples and files needed for the development of the models.

Table 7 shows a short guide with the links between each chapter and the files provided, the folder in which SWMM input files are allocated, as well as the supplementary files (such as backgrounds and rainfall series) and the name of each file. A brief description of each model example is included in SWMM input .inp files.

To use the data in this Manual, it is recommended to copy SWMM Manual folder (found in the zip) to hard disk root directory (C:\SWMM Manual).

Table 7. Supplementary files provided in the Manual.

EXAMPLE	Chapter	Folder	File name
PCEHU model	3	Ex 1.PCEHU	PCEHU_solved.inp
			Block_network.jpg
			Block_subcathments.jpg
Combined sewer network model	4	Ex 2.Combined sewer	Combined_sewer_initial.inp
			Combined_sewer_solved.inp
			Combined_sewer.jpg
			rain_T10.dat
CSO stormwater tank model	5	Ex 3.CSO tank	CSO_tank_initial.inp
			CSO_tank_T10.inp
			CSO_tank_annual_rain.inp
			rain_T10.dat
			average_year_18.xlsx
			average_year_18.dat

7 REFERENCES

- Adams, B.J. y Pappa, F. (2000). *Urban Stormwater Management Planning with Analytical Probabilistic Models*. New York: John Wiley & Sons.
- Augas de Galicia (2010). *Instrucciones técnicas para obras hidráulicas en Galicia*. Serie Saneamiento. Available on: https://augasdegalicia.xunta.gal/c/document_library/get_file?folderId=216484&name=DLFE-17836.pdf
- Puertas, J., Suárez, J., and Anta, J. (2008). *Gestión de las aguas pluviales. Implicaciones en el diseño de los sistemas de saneamiento y drenaje urbano*. Monografías CEDEX M98. Madrid: Centro de Publicaciones, Ministerio de Fomento.
- Rossmann, L. (2015). *Storm Water Management Model User's Manual Version 5.1* (revised version). U.S. Environmental Protection Agency, Office of Research and Development, Washington, DC, EPA/600/R-14/413 (NTIS EPA/600/R-14/413b). Available on: <https://nepis.epa.gov/Exe/ZyPDF.cgi?Dockey=P100N3J6.TXT>
- Rossmann, L., and Huber, W. (2016). *Storm Water Management Model Reference Manual Volume I, Hydrology* (revised version). U.S. Environmental Protection Agency, Office of Research and Development, Washington, DC, EPA/600/R-15/162A. Available on: <https://nepis.epa.gov/Exe/ZyPDF.cgi?Dockey=P100NYRA.txt> [Storm Water Management Model Reference Manual Errata: https://www.epa.gov/sites/production/files/2018-08/documents/swmm_reference_manual_errata.pdf].
- Rossmann, L. (2017). *Storm Water Management Model Reference Manual Volume II, Hydraulics*. U.S. Environmental Protection Agency, Office of Research and Development, Washington, DC, EPA/600/R-17/111. Available on: <https://nepis.epa.gov/Exe/ZyPDF.cgi?Dockey=P100S9AS.pdf> [Storm Water Management Model Reference Manual Errata: https://www.epa.gov/sites/production/files/2018-08/documents/swmm_reference_manual_errata.pdf].