

01

CEMENTERIO EN MERA [1:400] | BREA CASTRO, MARTIN (AZ.08)

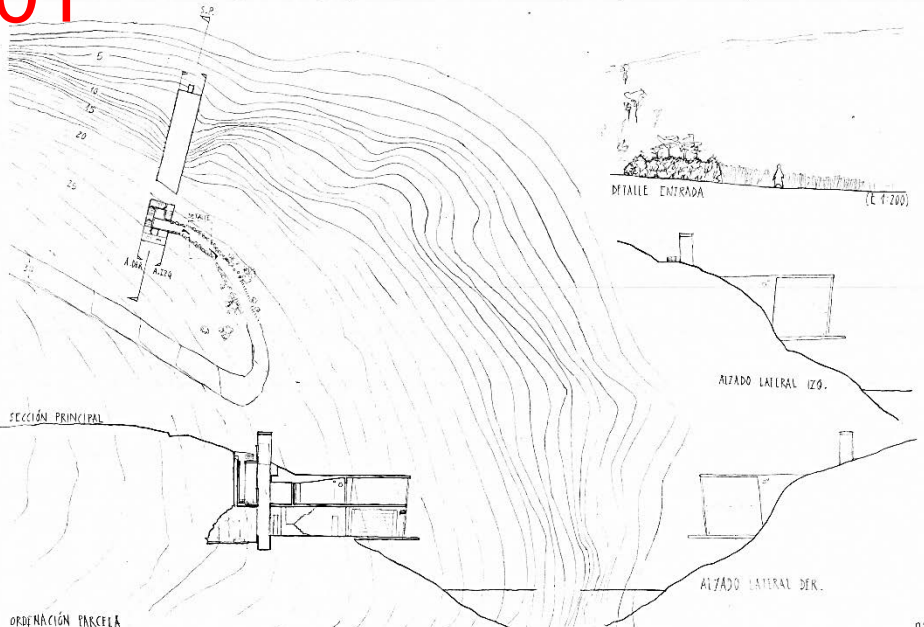

CEMENTERIO EN MERA [1:200] | BREA CASTRO, MARTIN (AZ.08)

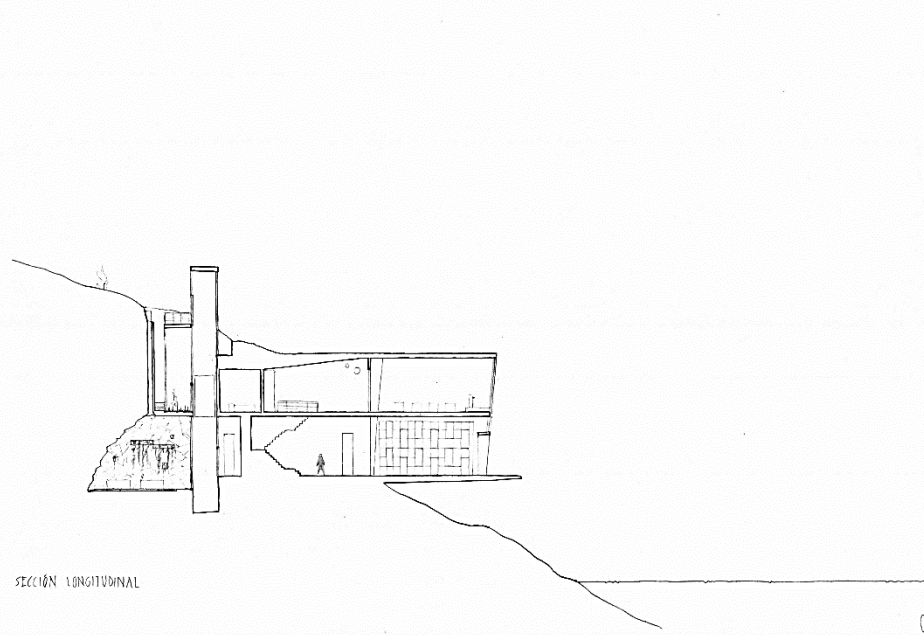

CEMENTERIO EN MERA [1:200] | BREA CASTRO, MARTIN (AZ.08)

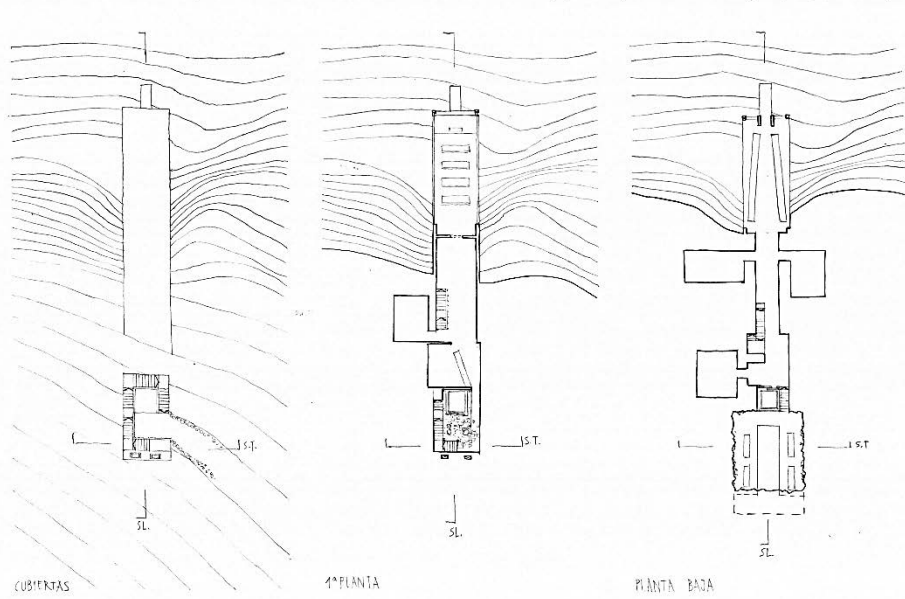

CEMENTERIO EN MERA [1:200] | BREA CASTRO, MARTIN (AZ.08)

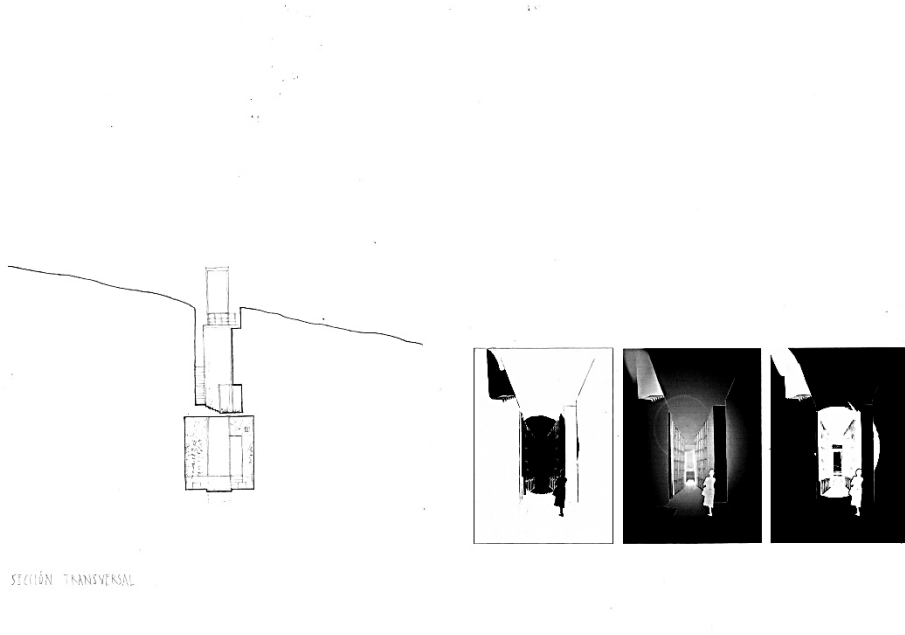

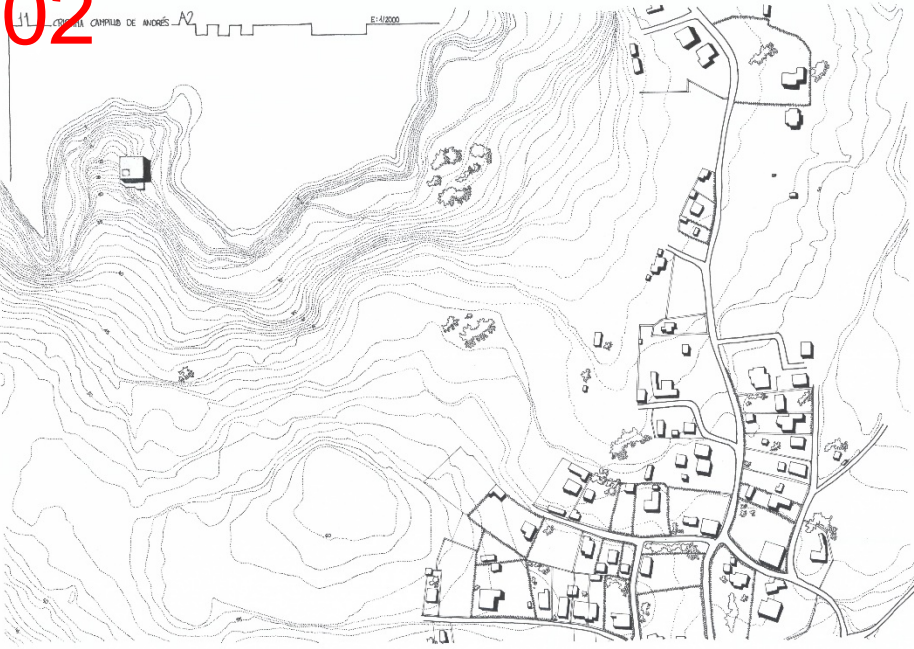

VUE B

Cristina Capullo de Andrés A2

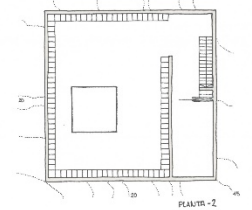
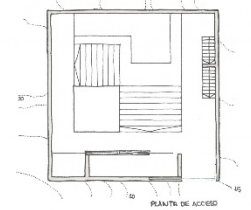
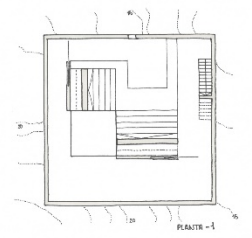
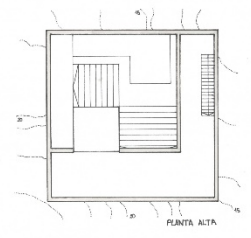
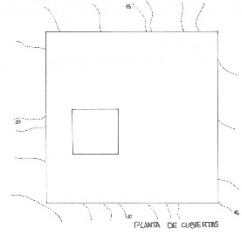

Cristina Capullo de Andrés A2

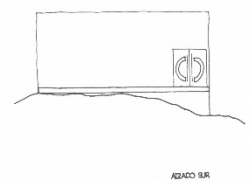

Cristina Capullo de Andrés A2

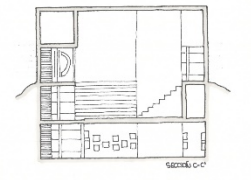
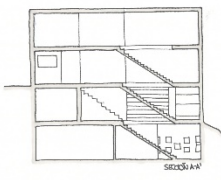
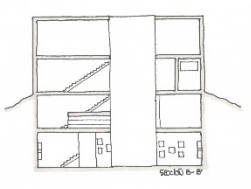
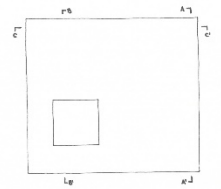



03h - EL CEMENTERIO

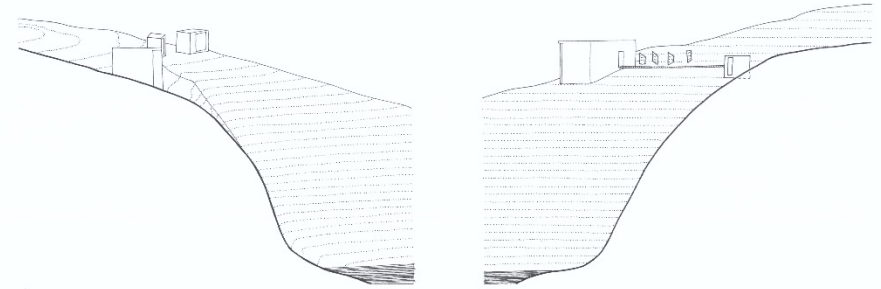
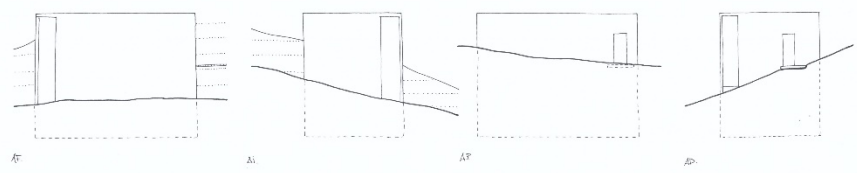
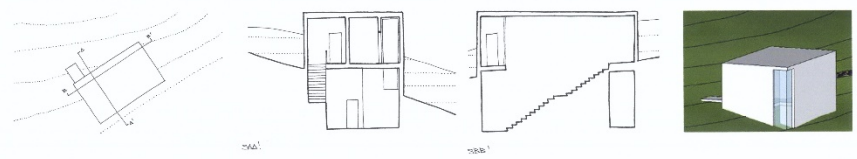
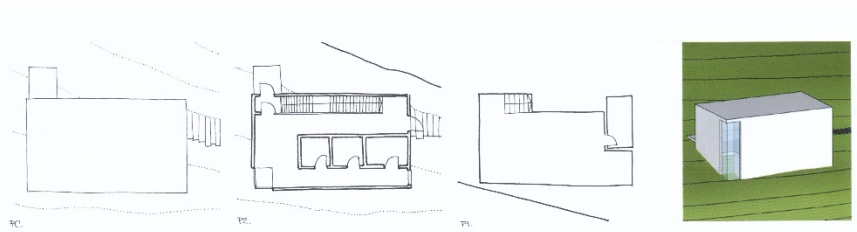

A1

A2

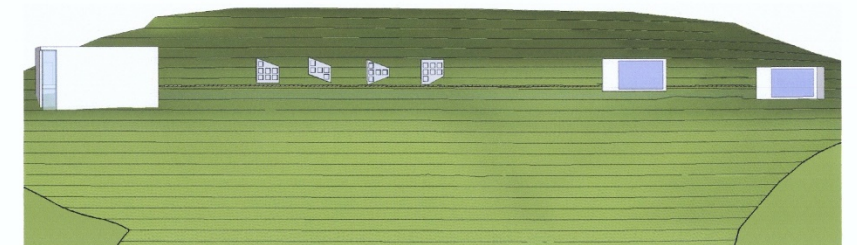
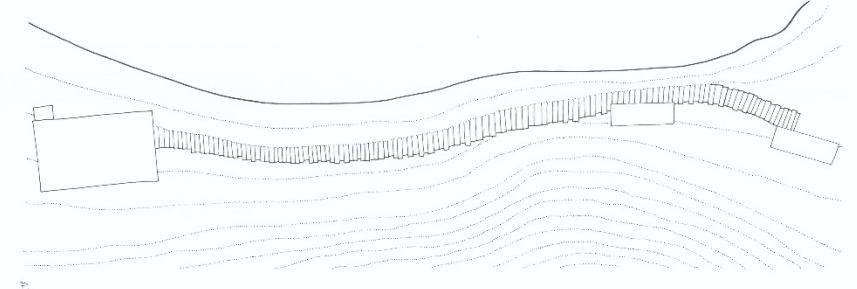
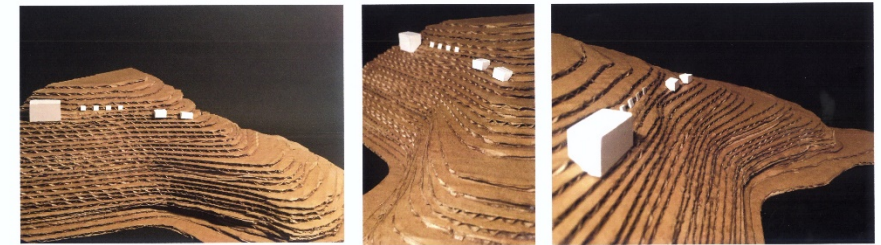

ASHES CEMETERY: SITE PLAN 1/500 PUIME FIGUEROA, CLARA-A3

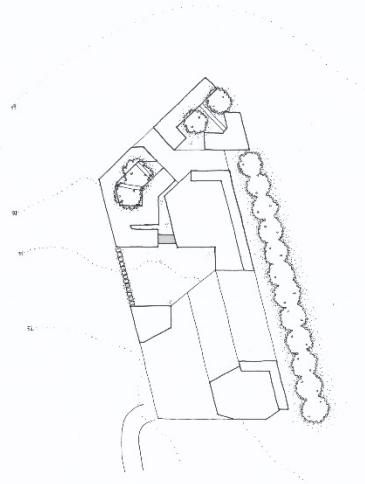

ASHES CEMETERY: CHURCH AND MEDITATION SPACE 1/200 PUIME FIGUEROA, CLARA-A3

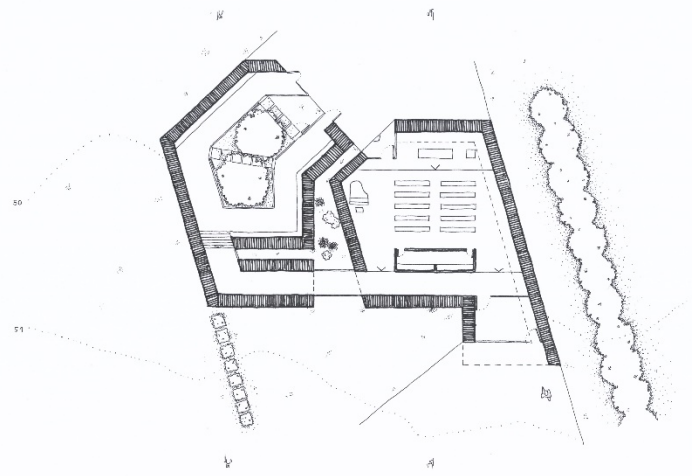

ASHES CEMETERY: COLUMBARIUM 1/100 PUIME FIGUEROA, CLARA-A3

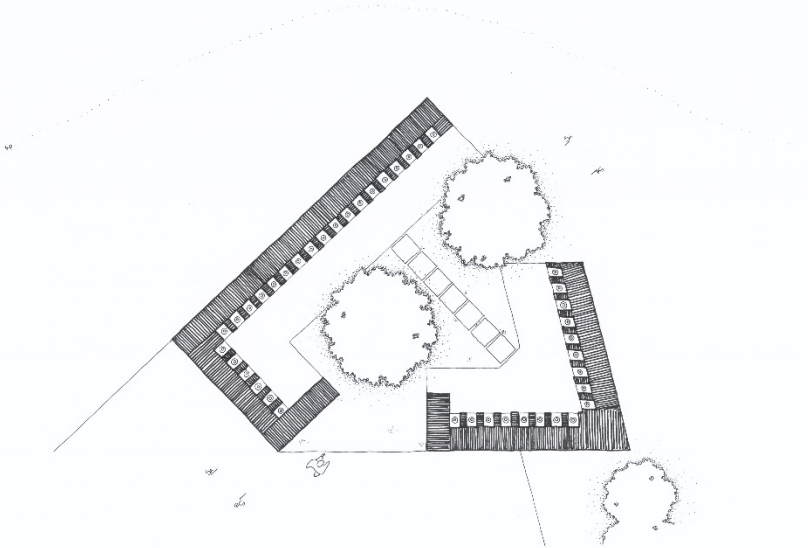

ASHES CEMETERY: CHURCH AND MEDITATION SPACE 1/100 PUIME FIGUEROA, CLARA-A3

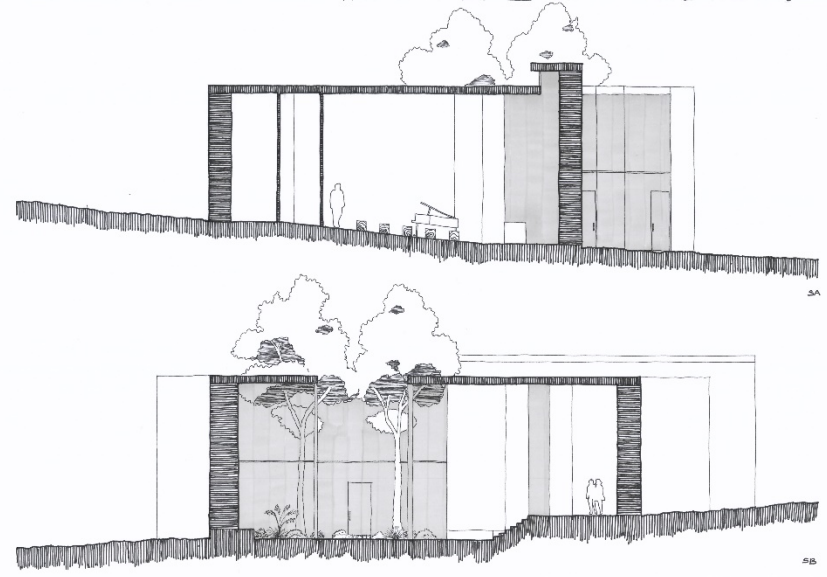

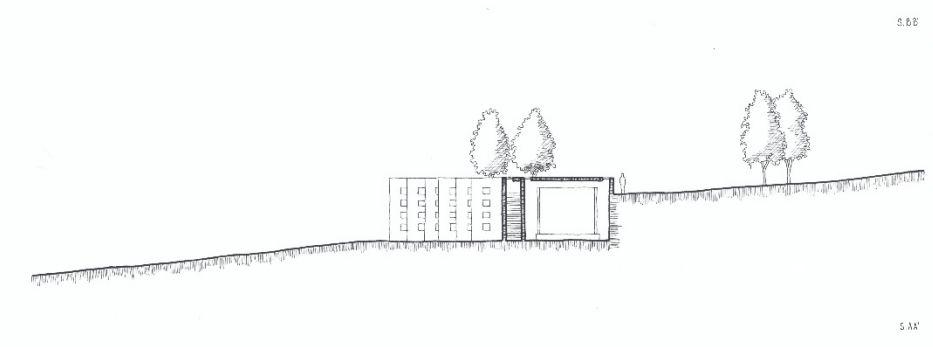
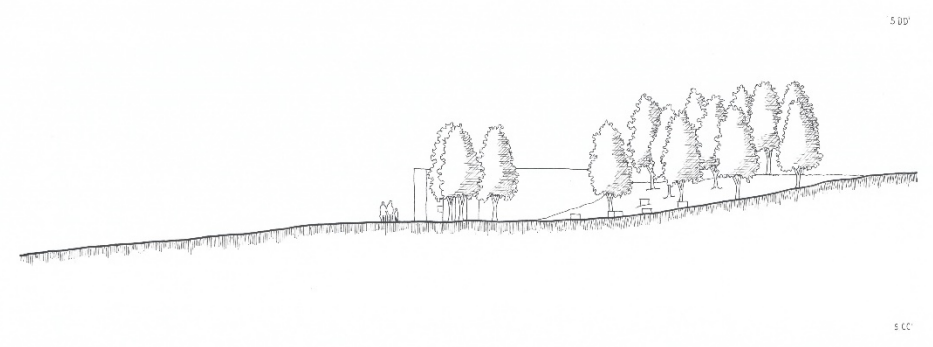
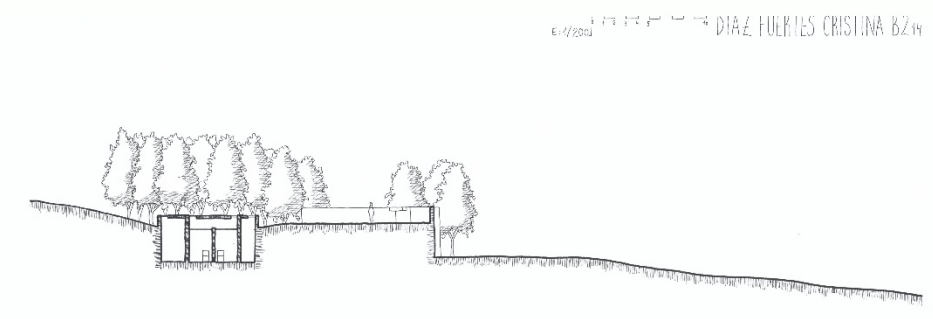
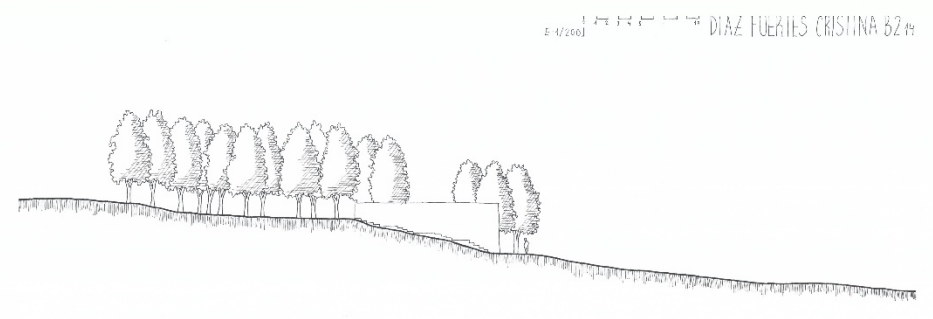
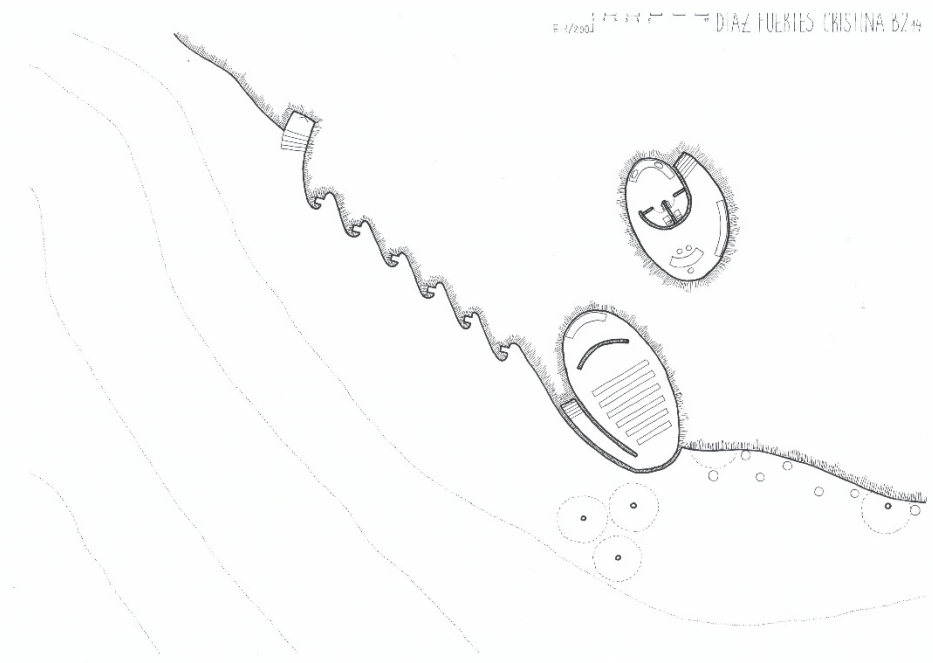
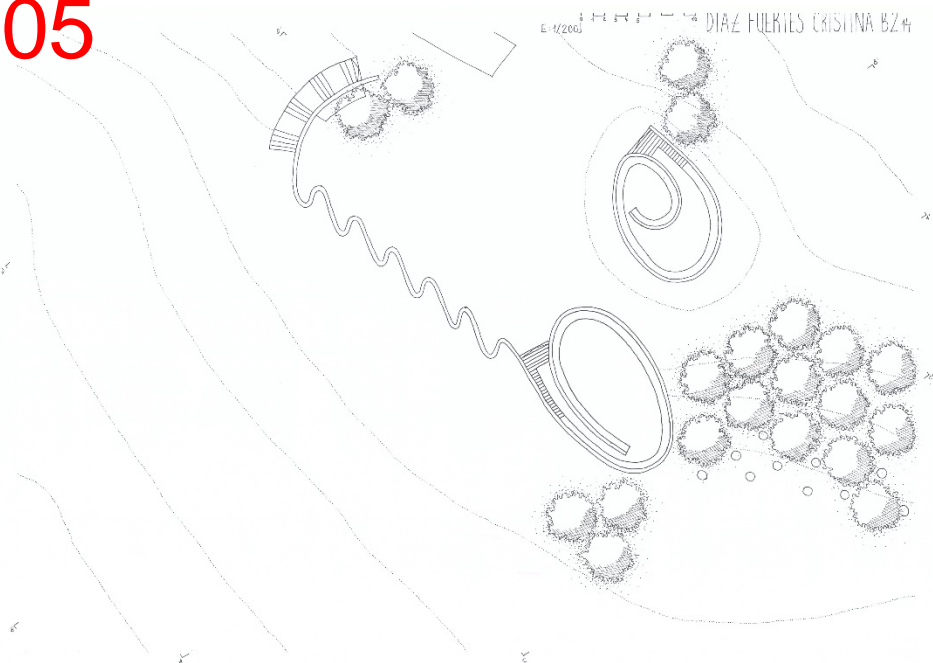

1:100 FLASH TRAYS

MOURIÑO FERNÁNDEZ, Uxía_A3

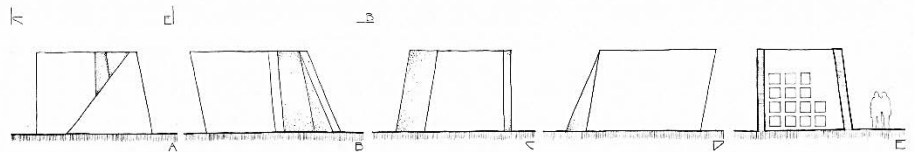
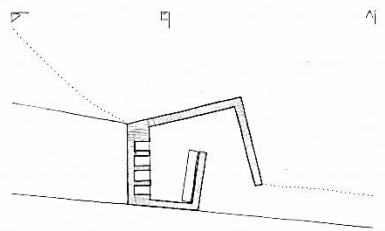

1:200 CEREMONIAL SPACE

MOURIÑO FERNÁNDEZ, Uxía_A3

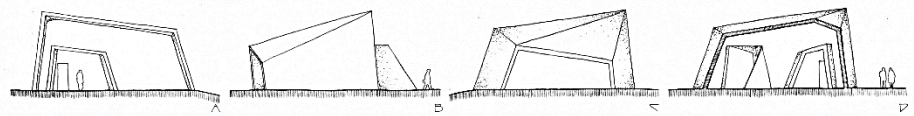
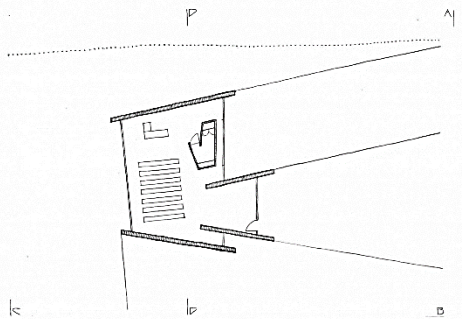

1:500 SITE PLAN

MOURIÑO FERNÁNDEZ, Uxía_A3

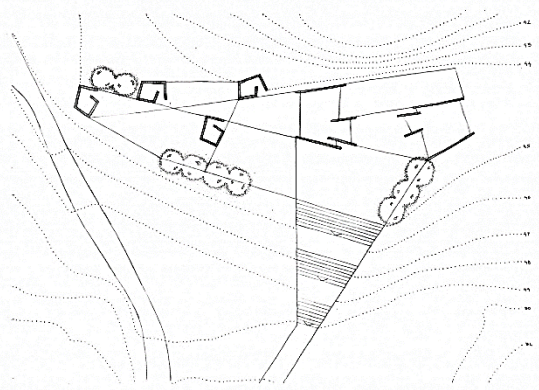

1:200 INFORMATION AND ADMINISTRATION

MOURIÑO FERNÁNDEZ, Uxía_A3

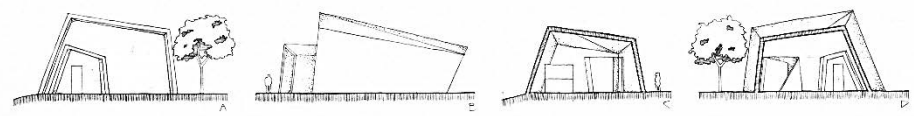
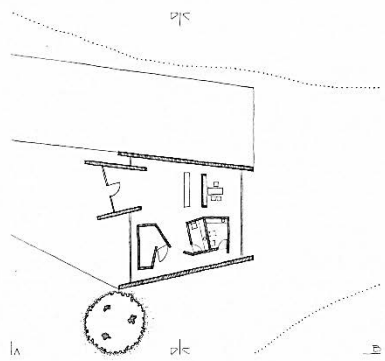

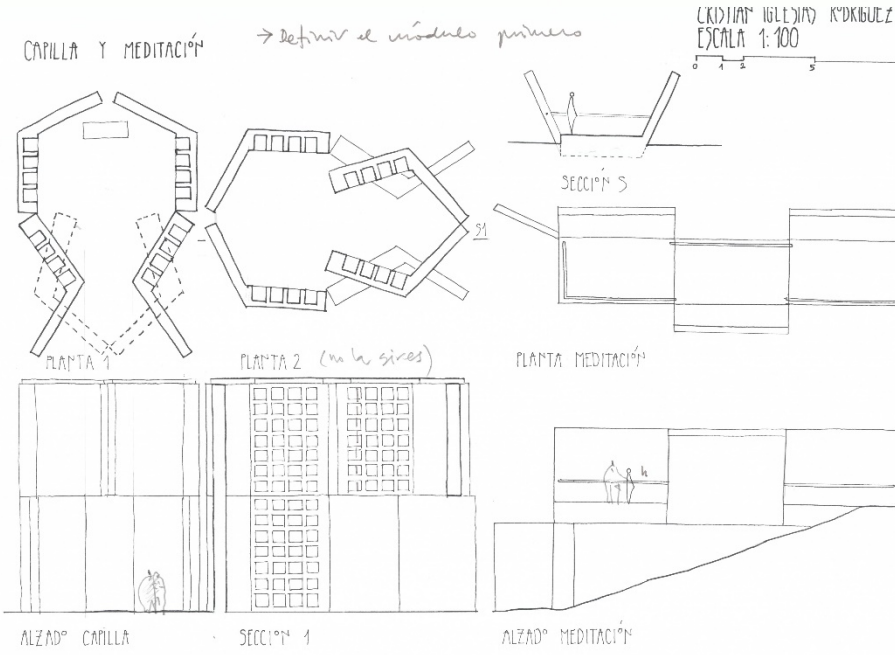
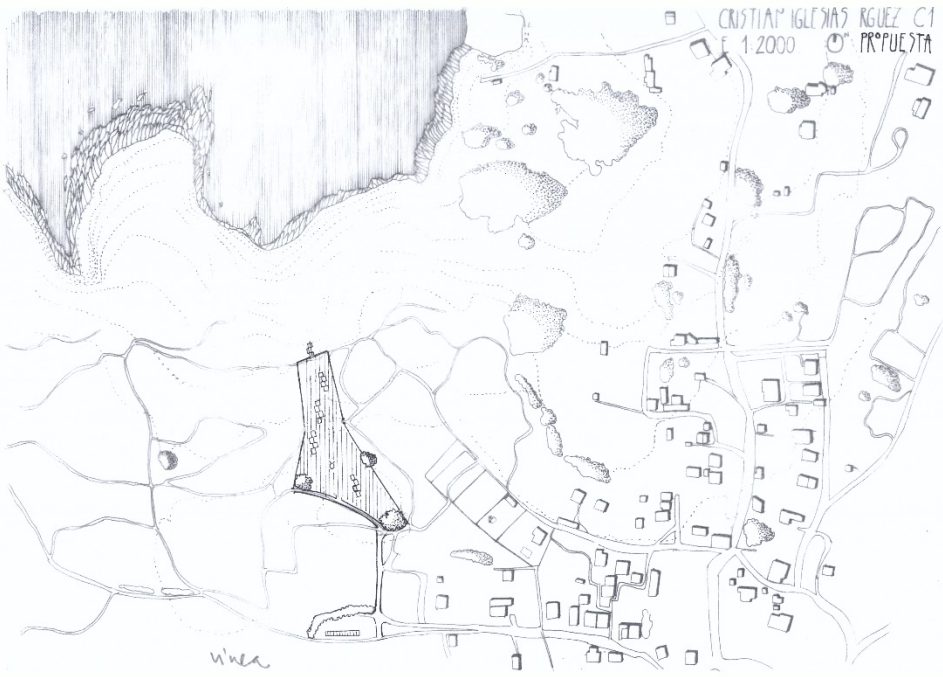
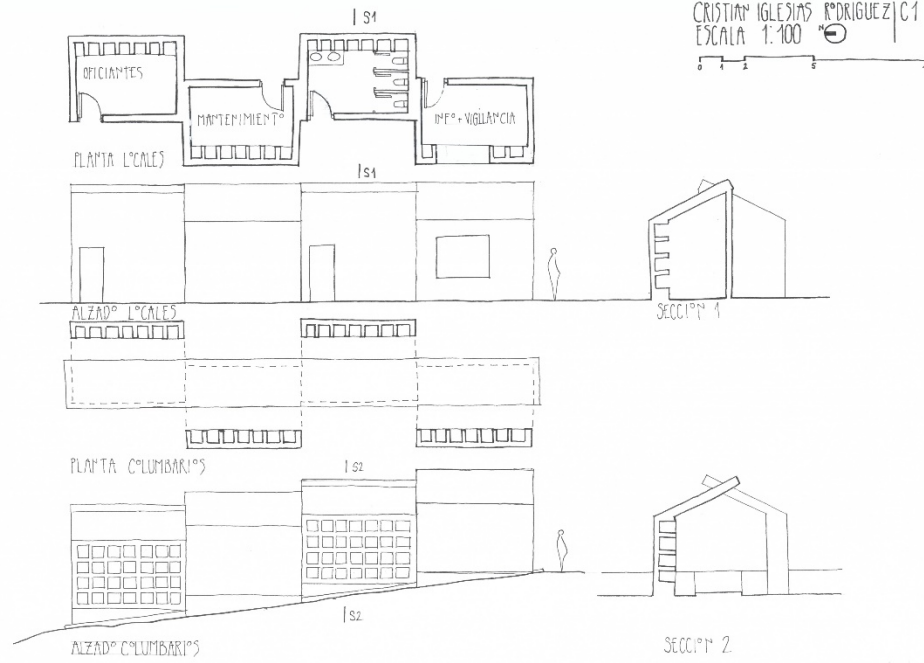
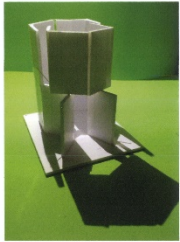

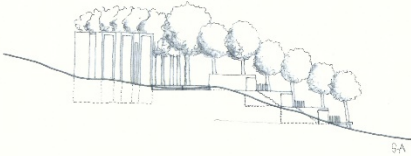
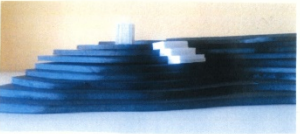
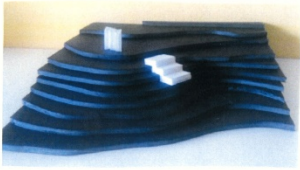

JESSTG AND ALLANES C2
MIRAGALLANES
0 5 10 20 30 40 50 60
1:500

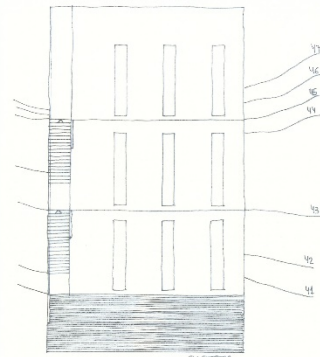

JESSTG AND ALLANES C2
MIRAGALLANES
0 5 10 20 30 40 50 60
1:300

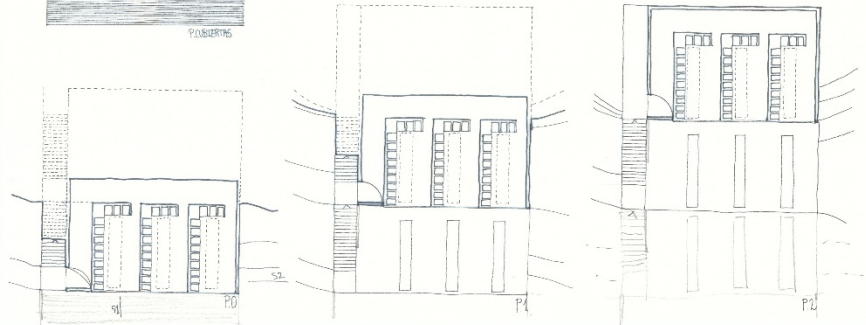
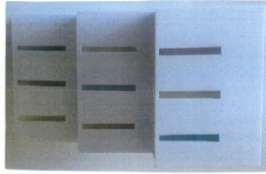

JESSTG AND ALLANES C2
MIRAGALLANES
0 5 10 20 30 40 50 60
1:300

JESSTG AND ALLANES C2
MIRAGALLANES
0 5 10 20 30 40 50 60
1:300

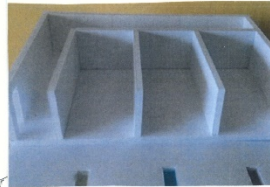
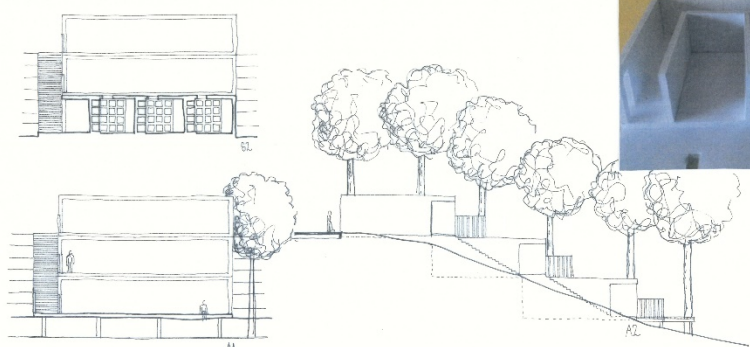
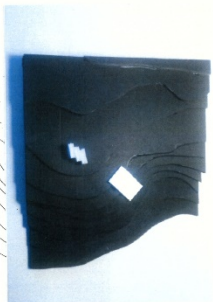
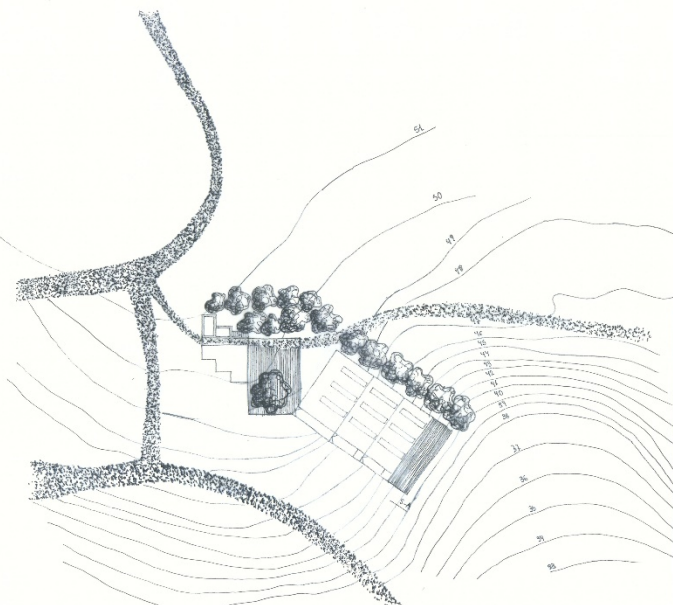
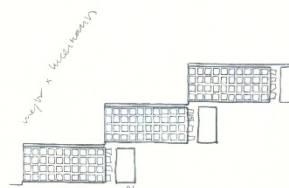

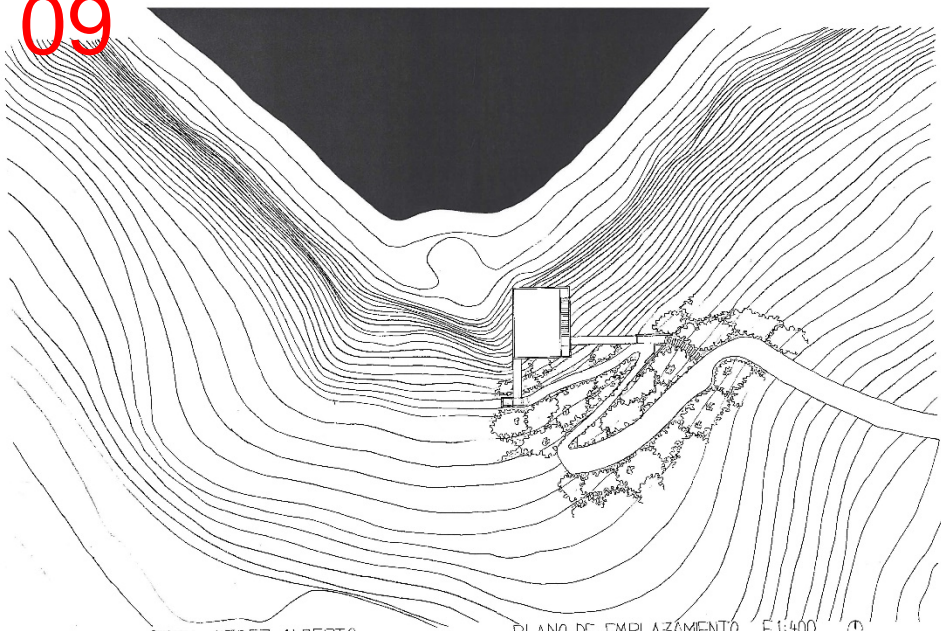

OTERO PEREZ ALBERTO PLANO DE EMPLAZAMIENTO E:1:400

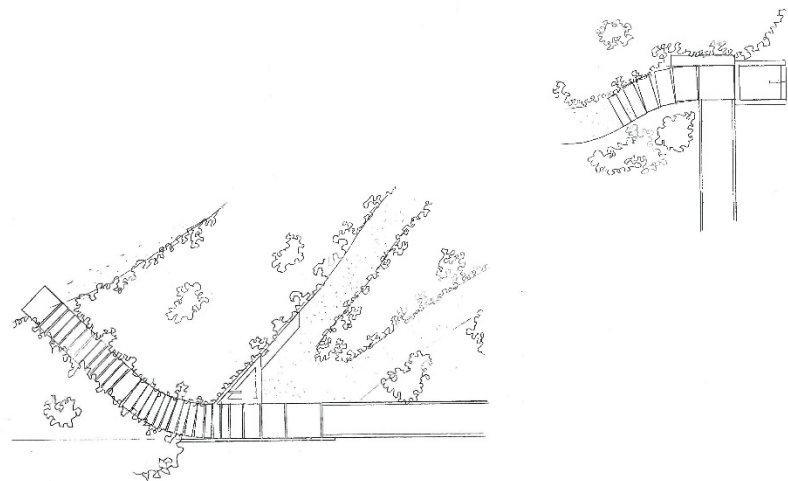

OTERO PEREZ ALBERTO ARRANQUES DE RAMPA E:1:100

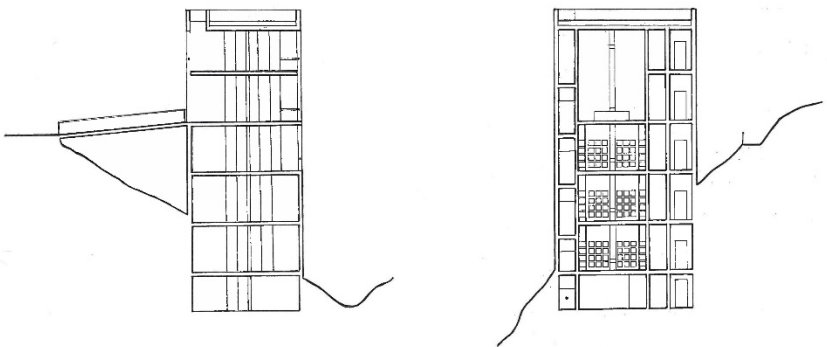

OTERO PEREZ ALBERTO PLANTAS E:1:200

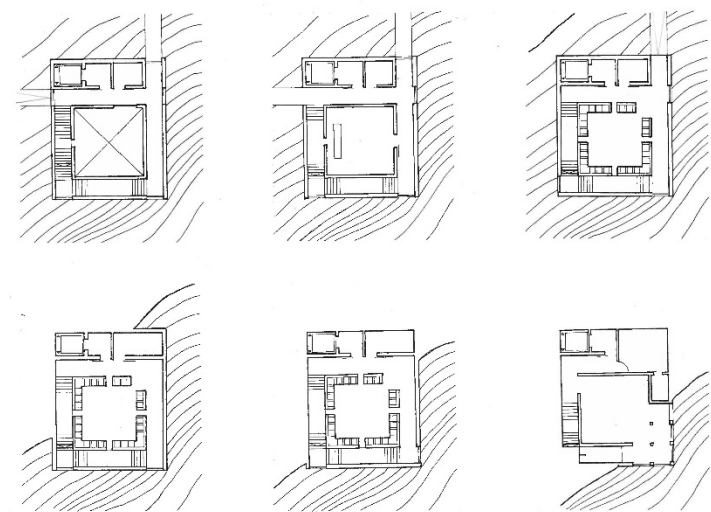

OTERO PEREZ ALBERTO PLANTAS E:1:200

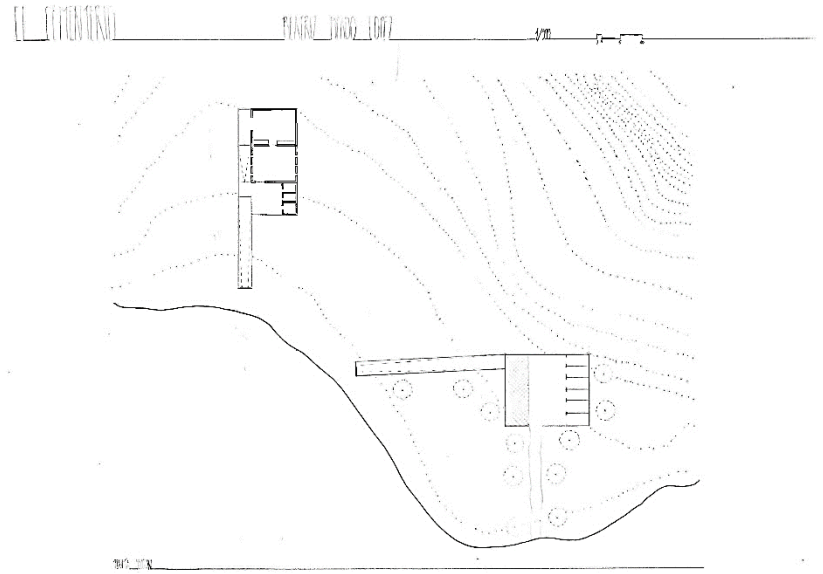
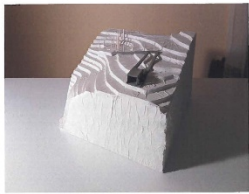

EL CEMENTERIO ENRIQUE JORDA LÓPEZ 1/200

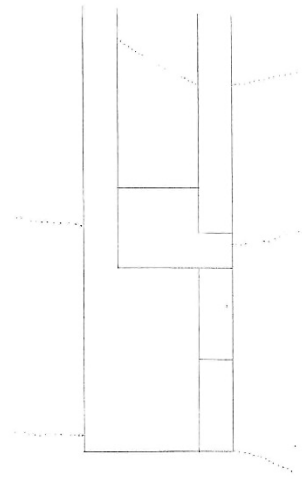
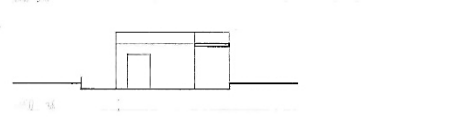
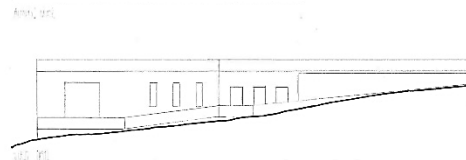
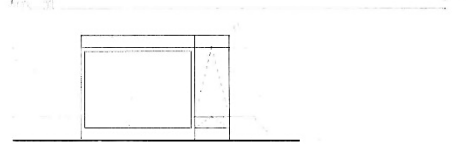
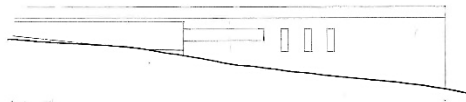

EL CEMENTERIO ENRIQUE JORDA LÓPEZ 1/200

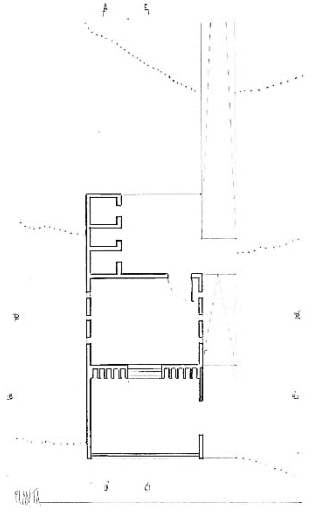
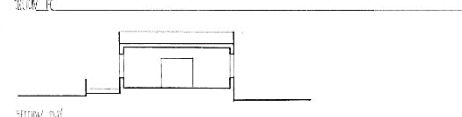
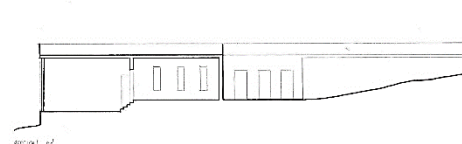
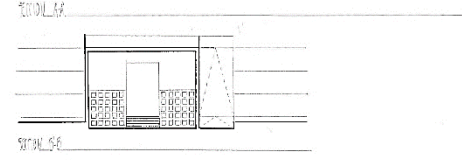
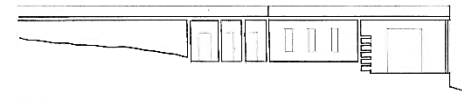

KEVIN PRIETO SÁNCHEZ

CEMENTERIO DE CENIZAS

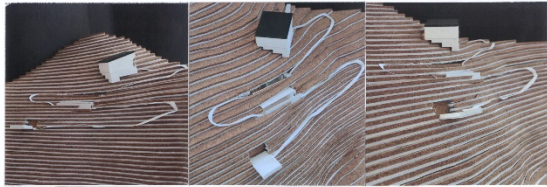

2. COLUMBARIOS

KEVIN PRIETO SÁNCHEZ

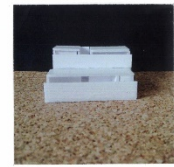
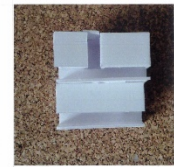
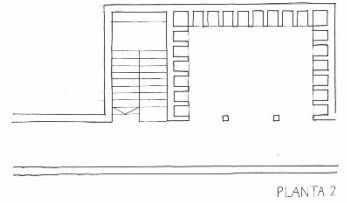
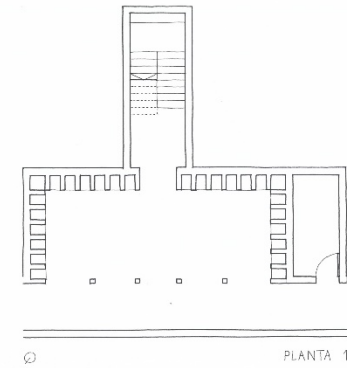
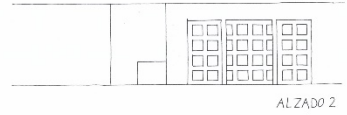
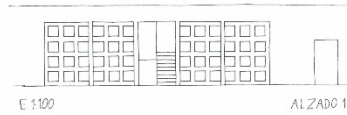

1. CAPILLA

KEVIN PRIETO SÁNCHEZ

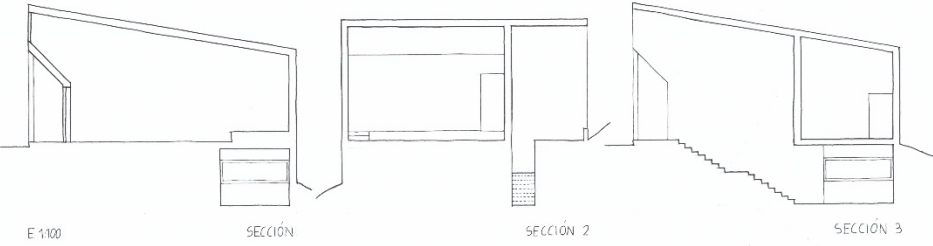

KEVIN PRIETO SÁNCHEZ

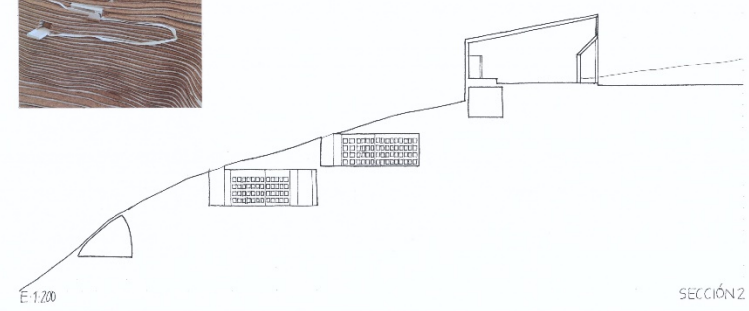
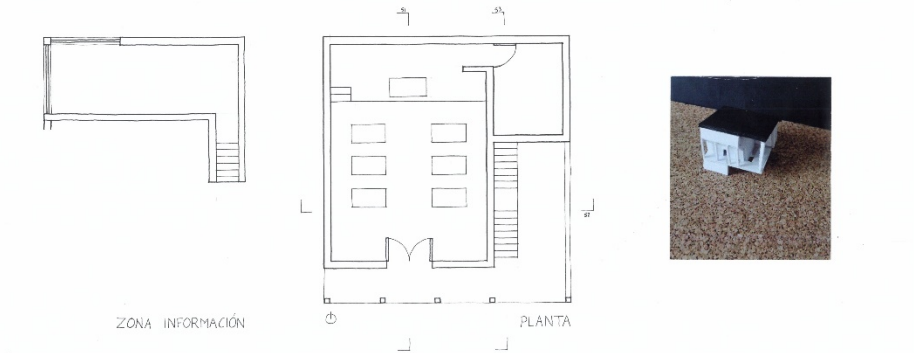
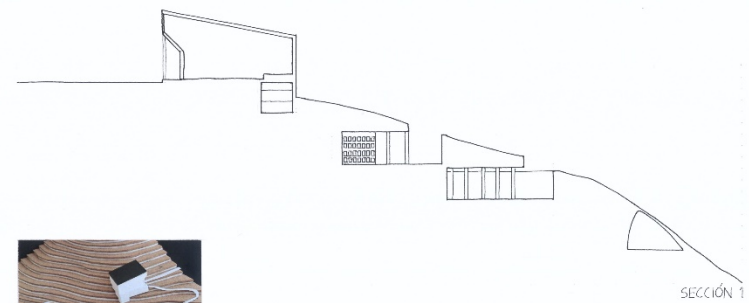

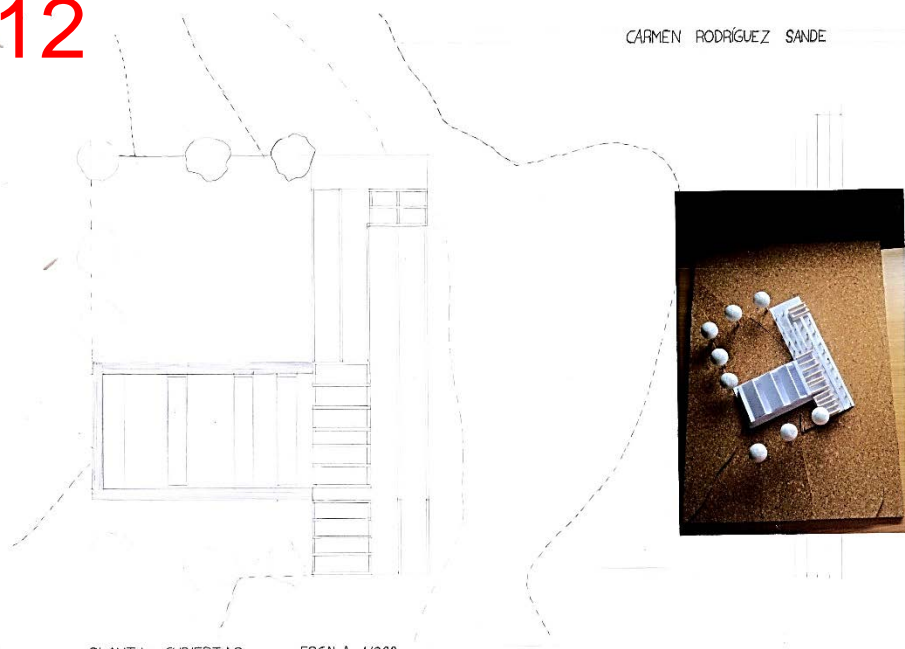

PLANTA CUBIERTAS ESCALA: 1/200

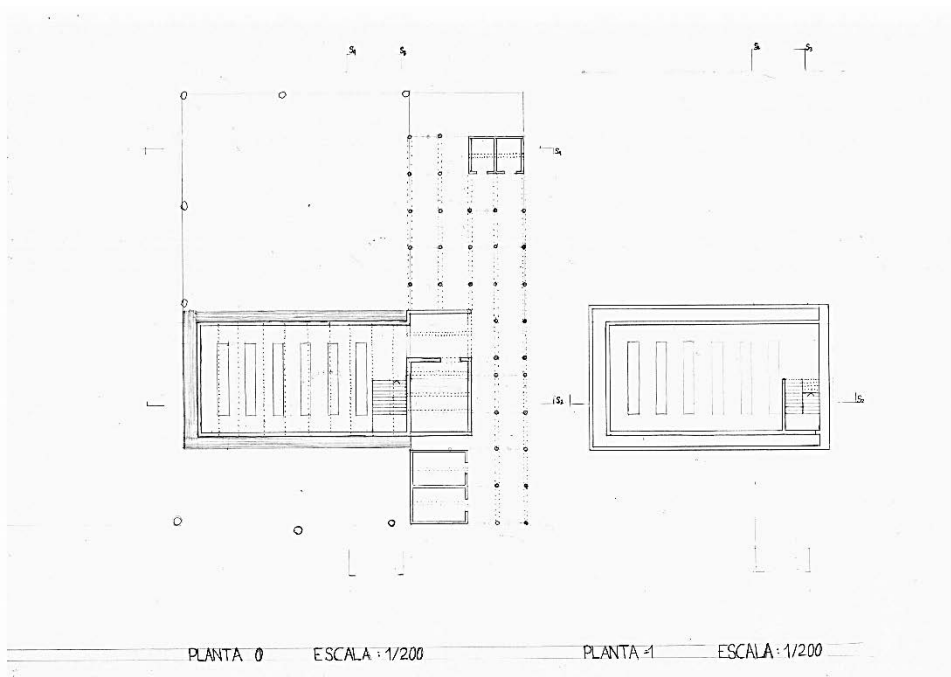
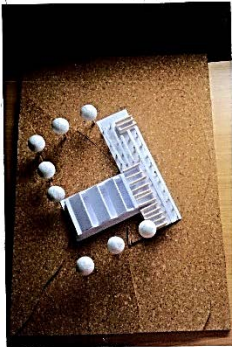

PLANTA 0 ESCALA: 1/200 PLANTA 1 ESCALA: 1/200

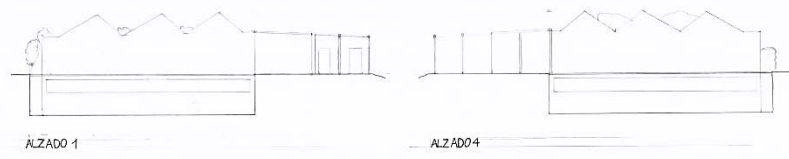

ALZADO 1 ALZADO 4

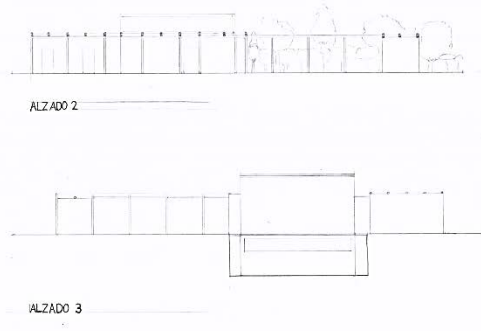

ALZADO 2 ALZADO 3

ESCALA: 1/200

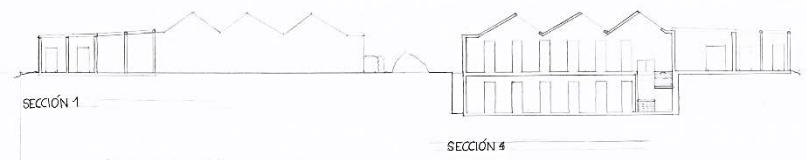
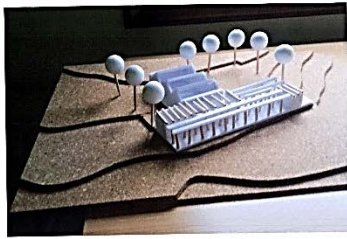

SECCIÓN 1 SECCIÓN 4

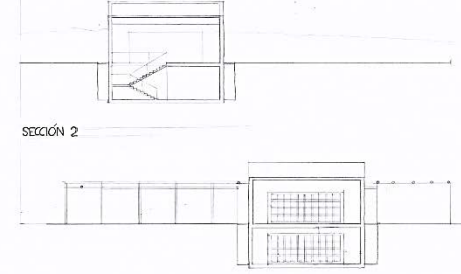

SECCIÓN 2 SECCIÓN 3

ESCALA: 1/200

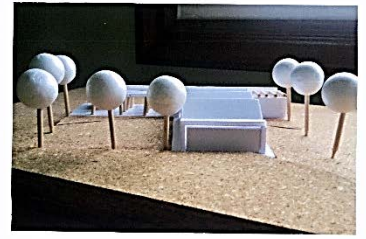

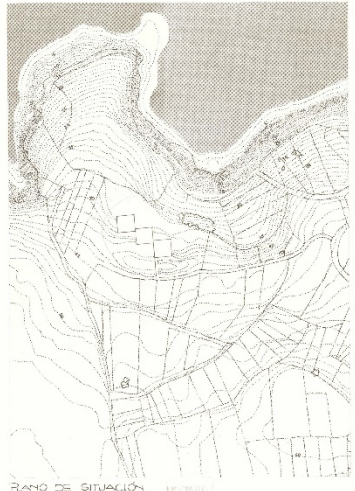

PLANO DE SITUACIÓN

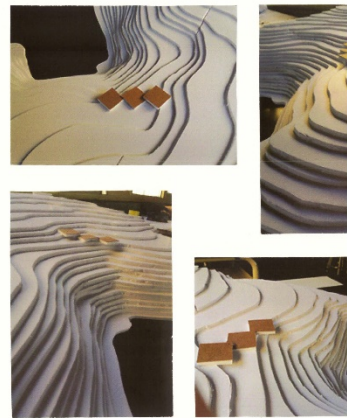

MAQUETA GRUPAL

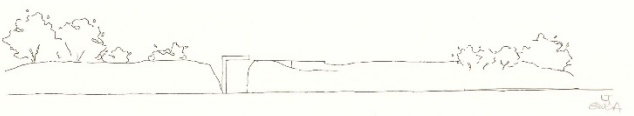

ALZADO 1 (ENTRADA)

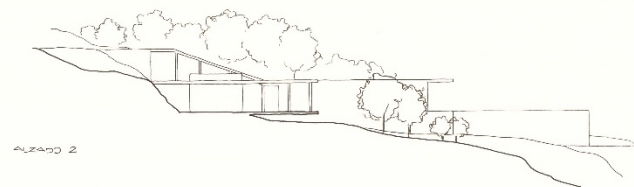

ALZADO 2



SECCIÓN TRANSVERSAL 1

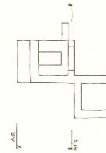

PLANTA -1

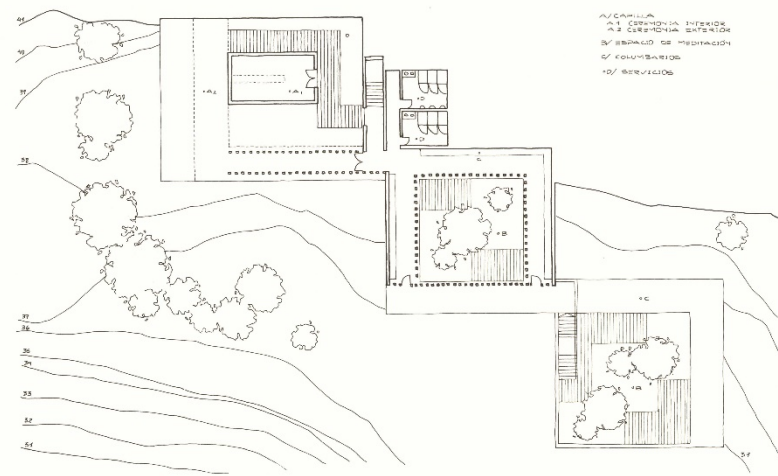

ALCAPILLA
AL CERRAMIA INTERIOR
AL CERRAMIA EXTERIOR
SERVIDORIO DE INSERCIÓN
SERVIDORIO
SERVIDORIO

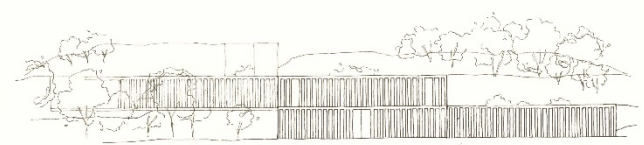

ALZADO 3, FACUDA

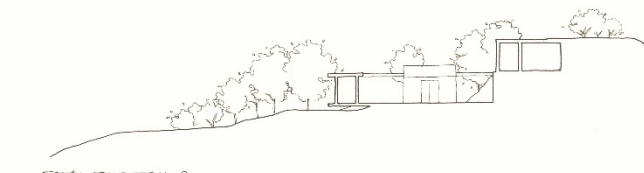

SECCIÓN TRANSVERSAL 2

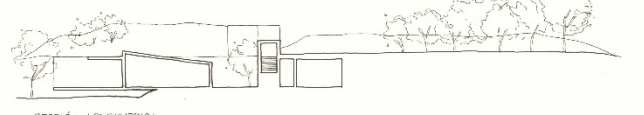
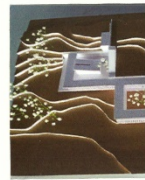

SECCIÓN LONGITUDINAL

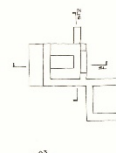

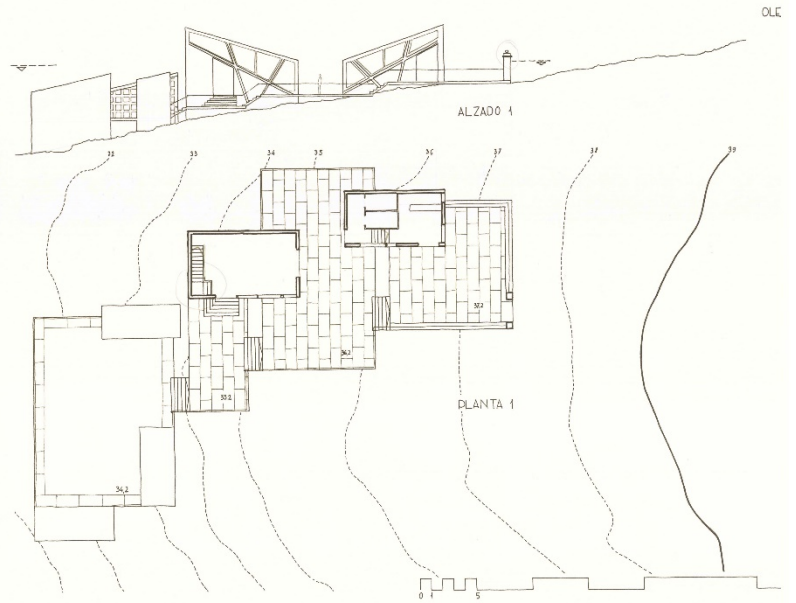
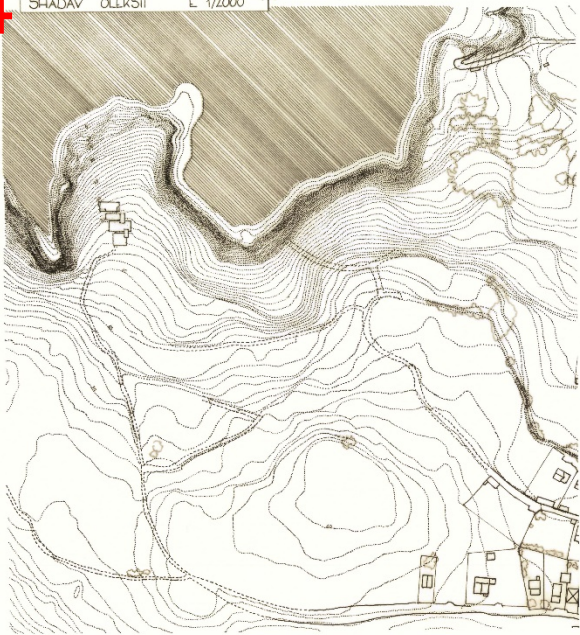

OLE

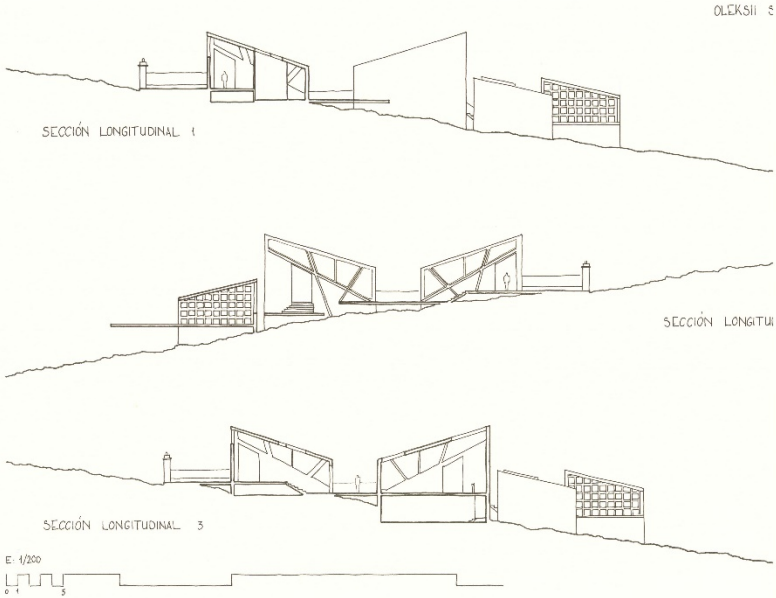

OLEKSII

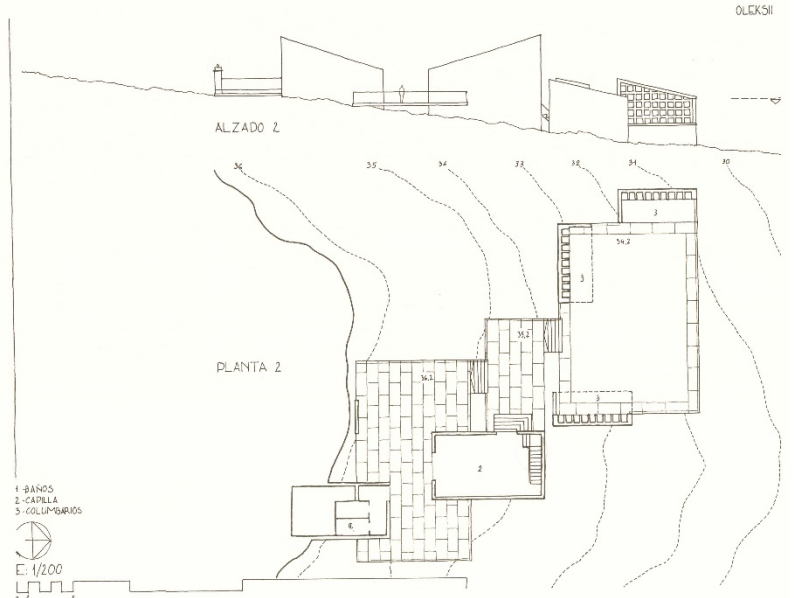

OLEKSII

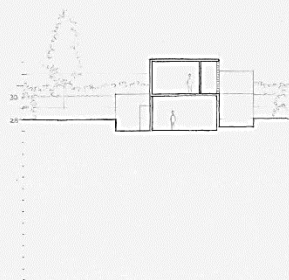
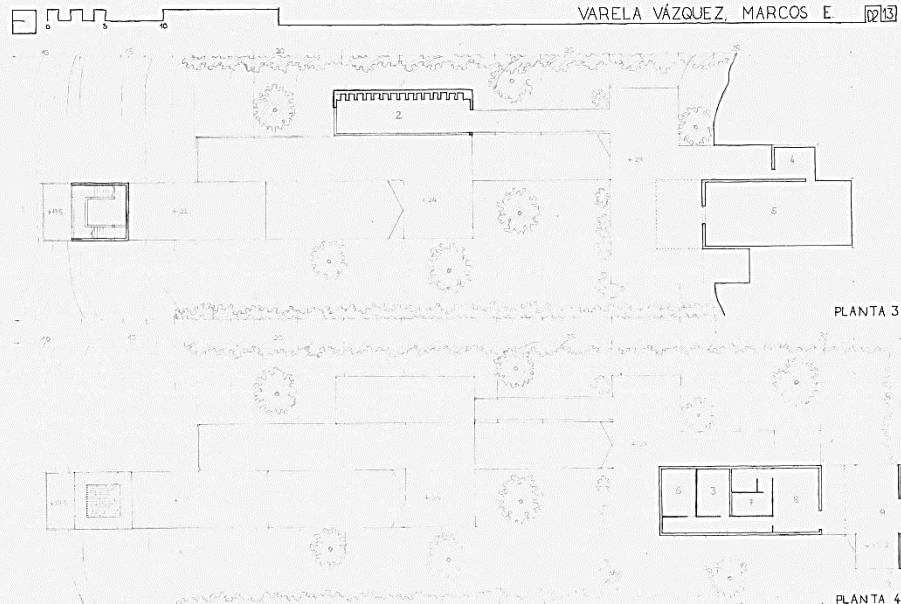

SECCIÓN A

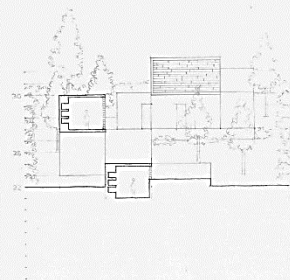

SECCIÓN B

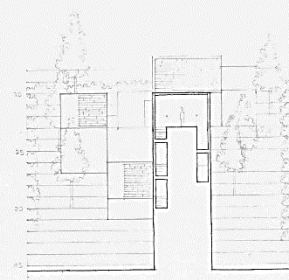

SECCIÓN C

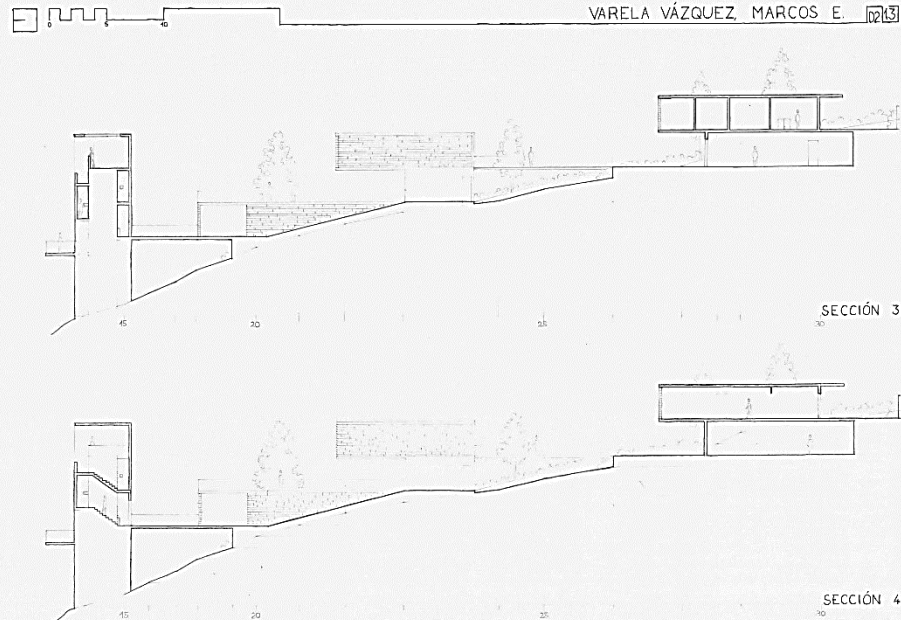

SECCIÓN 3

SECCIÓN 4

ALONSO TABOADA, CLAUDIA
ARQUINO E HILARDO REY HONORE
1/100

ALONSO TABOADA, CLAUDIA
ARQUINO E HILARDO REY HONORE
1/100

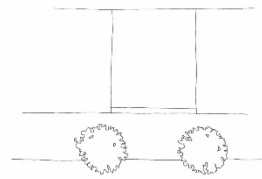
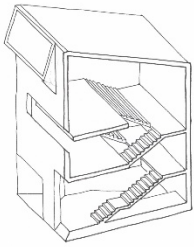

PLANTA P ENRAZAMIENTO 1/200

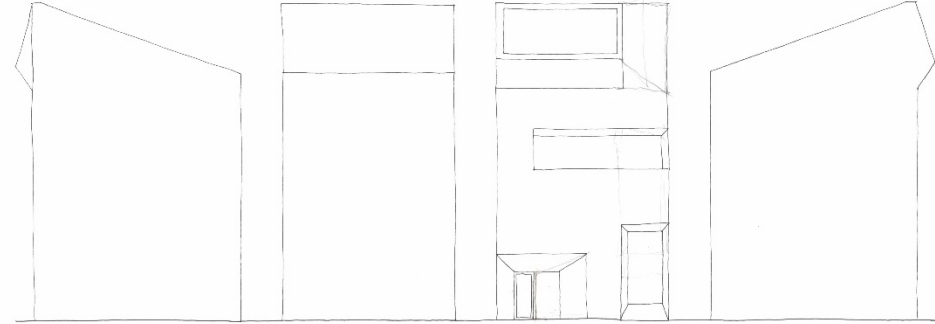
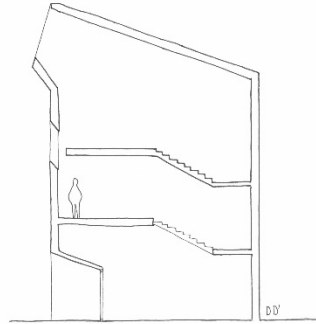

ALZADO OESTE

ALZADO NORTE

ALZADO SUR

ALZADO ESTE

ALONSO TABOADA, CLAUDIA
ARQUINO E HILARDO REY HONORE

ALONSO TABOADA, CLAUDIA
ARQUINO E HILARDO REY HONORE
1/100

SECCIONES

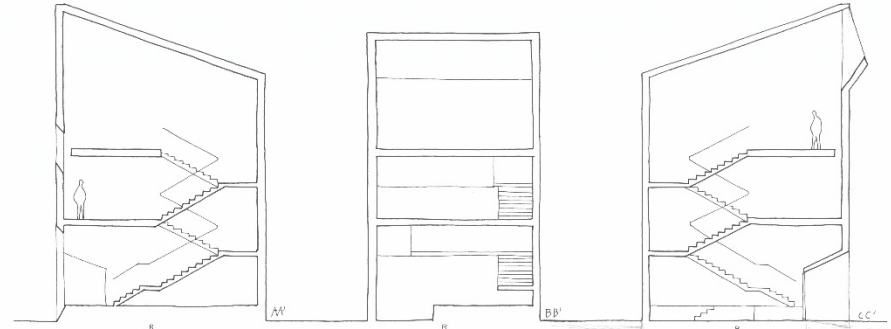

B-B

A-A

B-B

C-C

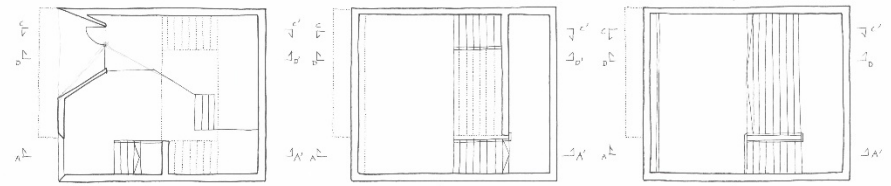

PLANTA BAJA

PLANTA 1

PLANTA 2

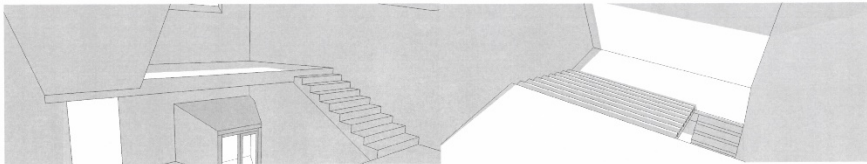
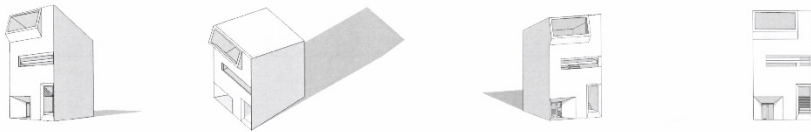

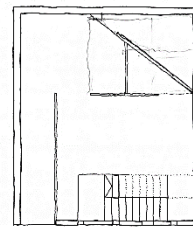
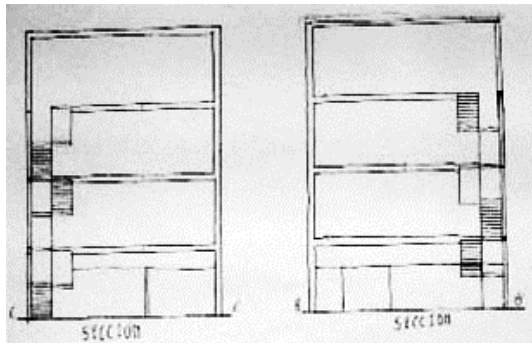
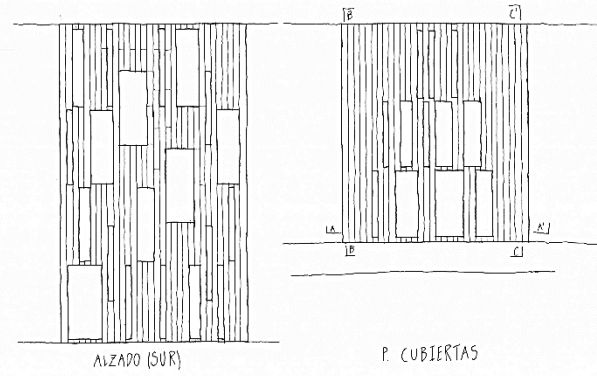

P. BAJA

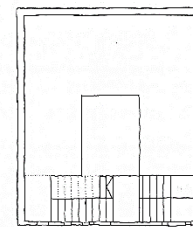

P. 1º

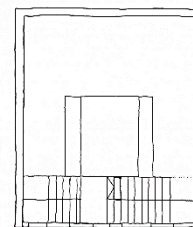

P. 2º

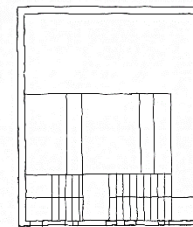

P. 3º

